



- Frese dentali
- Perni radicolari
- Punte ultrasoni
- Sbiancamento dentale

CATALOGO

2022-23



Benvenuti

Siamo lieti di condividere con i nostri stimati clienti il nostro **Catalogo Axis Dental 2022-23**, in cui presentiamo informazioni complete e dettagliate della nostra vasta gamma di prodotti.

Sin dalla fondazione della nostra azienda in Svizzera nel 1998, abbiamo lavorato sotto la spinta dell'innovazione continua per poter offrire la massima **qualità ed efficienza** dei nostri prodotti e raggiungere così la soddisfazione di dentisti, tecnici di laboratorio e, naturalmente, dei pazienti.

Il nostro impegno per migliorare ci ha portato in questi ultimi anni verso un processo di trasformazione digitale dell'azienda, tramite il quale desideriamo facilitare la comunicazione con i nostri clienti attraverso il nostro sito web e le reti sociali.

Recentemente abbiamo inaugurato anche il **nostro negozio online**, un'iniziativa che ci permette una maggiore velocità d'azione e flessibilità ad ogni livello.

In parallelo, continuiamo a servire dal contatto diretto e umano della nostra vasta **rete commerciale** in Svizzera, Spagna, Portogallo e Bulgaria, che stabilisce un legame di assistenza continua ai nostri clienti che permette loro di osservare necessità che ci spingano a continuare a creare.

In questo catalogo includiamo, oltre ai riferimenti delle nostre più di 1000 modalità di **frese dentali, perni dentali e trattamenti di sbiancamento dentale**, informazioni utili per i dentisti sugli usi, mantenimento e conservazione degli strumenti dentali. Perché la qualità e la durabilità dei nostri prodotti è ciò che ci definisce e ciò su cui si basano la fiducia e la fedeltà dei nostri clienti.

Grazie per averci scelto.

Jean-Paul Berclaz Dominique Rahm

Soci
[Axis Dental](#)

AXIS Dental Sarl

Ch. du Cloalet 4
1023 Crissier - Switzerland
Tel: +41 21 633 0 633
Email: mail@axis-dental.ch

www.axis-dental.com

Progettazione e realizzazione: www.laurasalesa.com

La *Garanzia* è nella
nostra esperienza.

CONTENUTI



La nostra azienda



Garanzia



Rete Internazionale



Prodotti

FRESE DENTALI



introduzione e caratteristiche

Studio
Diamantate
Carburo
Ceramica
Lucidaltrici

Laboratorio
Diamantate
Carburo
Lucidaltrici

12



PERNI RADICOLARE



introduzione e caratteristiche

Fibra di vetro

192



SBIANCAMENTO DENTALE



introduzione e caratteristiche

In studio
A casa

216





Axis Dental è un'azienda specializzata nella fabbricazione, commercializzazione e distribuzione di frese dentali, punte a ultrasuoni, perni radicolari e soluzioni per lo sbiancamento dentale.

Filosofia

La nostra filosofia è caratterizzata dalla **fabbricazione di strumenti precisi ed efficaci di alta qualità** con una maggiore durata e che permettano di risparmiare materiale all'odontoiatra.

Trattamento personalizzato: prossimità e professionalità

Il nostro obiettivo di lavoro è ottenere la fiducia dei professionisti dell'odontoiatria con l'appoggio di un'equipe di professionisti formati con un chiaro orientamento verso il cliente.



I nostri clienti sottolineano la qualità e la durata dei prodotti di Axis Dental.

Dominique Rahm
Direttore vendite e marketing di Axis Dental

Missione



Axis Dental cerca l'eccellenza nella qualità dei suoi prodotti e dei suoi servizi. La professionalità del personale di Axis Dental può soddisfare in modo competente le necessità e aspettative dei nostri clienti.

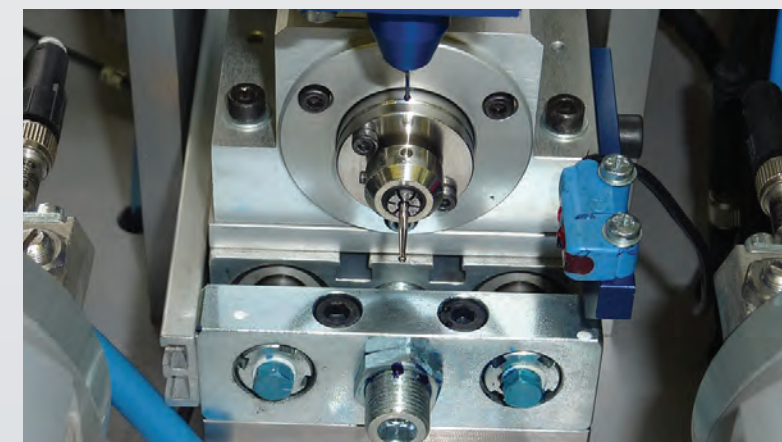

La nostra azienda



Creata nel 1998 in Svizzera, Axis Dental ha come obiettivo offrire ai professionisti del settore dentale le migliori soluzioni che facilitino il loro lavoro grazie a materiali di ultima generazione.

Qualità ed Esperienza

I nostri strumenti dentali si sviluppano e si producono in Svizzera, garantendo la massima qualità.

I processi di produzione vengono eseguiti utilizzando apparecchiature moderne e una supervisione esaustiva di ogni fase del lavoro. Tutti i prodotti di Axis Dental rispettano le norme europee più rigorose.



Consideriamo essenziale offrire con convinzione e onestà il prodotto partendo dalla qualità dello stesso. Trasmettere al cliente che ha un buon prodotto.



Impegno

Axis Dental cerca l'eccellenza nella qualità dei suoi prodotti e servizi. La precisione, la qualità e il servizio sono i valori che ci fanno evolvere.

Sin dalla sua creazione, Axis Dental si è guadagnata la fiducia dei professionisti, grazie al suo servizio personalizzato, disponibilità e prodotti di alta qualità.

La nostra garanzia si basa sulla nostra missione per il miglioramento continuo e l'adeguamento ai processi e normative attuali.

Gestione della qualità internazionale

I nostri dispositivi medici si producono nel rispetto delle norme internazionali ISO 13485.

Certificato Comunità europea

Tutti i nostri prodotti medici hanno il marchio CE e soddisfano le disposizioni della Direttiva 93/42/EEC.

Garanzia





La nostra azienda ha il proprio laboratorio di fabbricazione in Svizzera, oltre alle delegazioni in Spagna, Portogallo e Bulgaria. È anche presente attraverso distributori in diversi paesi.

Distribuzione Internazionale

Axis Dental conta su una rete di vendita internazionale capace di fornire assistenza di qualità ai nostri clienti e soci.

Ad Axis Dental c'è sempre un esperto vicino a te. Abbiamo una grande équipe di tecnici commerciali, per fare in modo che i nostri prodotti siano accessibili in tutte le cliniche e laboratori delle nostre zone di distribuzione.

La professionalità del personale di Axis Dental può soddisfare in maniera competente le necessità e aspettative dei nostri clienti.

Rete internazionale

Vicino a Voi

La nostra eccellenza nel rapporto con i nostri clienti si fonda su 4 pilastri:

- ✓ Assistenza post-vendita
- ✓ Premiamo la vostra fedeltà
- ✓ Personalizziamo Kit secondo le tue necessità
- ✓ Offriamo formazione sui nostri prodotti

Kit personalizzati

Le nostre soluzioni includono una vasta gamma di riferimenti in frese dentali sia per il lavoro in clinica sia in laboratorio. Tutte incorporano i migliori materiali garantendo efficacia, precisione, rapidità di taglio, geometrie perfette e assenza di vibrazioni.

Possiamo creare un kit personalizzato che si adatti alle necessità e dinamiche del lavoro del dentista, sia in clinica sia in laboratorio.



Formazione del professionista

Come parte del nostro impegno con lo sviluppo dei professionisti attuali e del futuro, Axis Dental in Spagna ha sviluppato Formazione AD, un programma di formazione adattato ai progressi e alle nuove tecniche di lavoro nell'ambito dell'odontoiatria.

I nostri laboratori, specializzati nell'area del restauro ed estetica dentale, hanno una componente teorico-pratica che permette ai partecipanti di rafforzare i concetti impartiti da professionisti riconosciuti in tutto il mondo.

Scopri la nostra offerta formativa disponibile per sviluppare le tue competenze professionali al più alto livello.





FRESE DENTALI

AXIS
dental
SWISS QUALITY

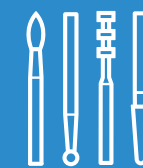

*Strumenti
essenziale per
l'odontoiatria*





FRESE DENTALI

AXIS
dental
SWISS QUALITY

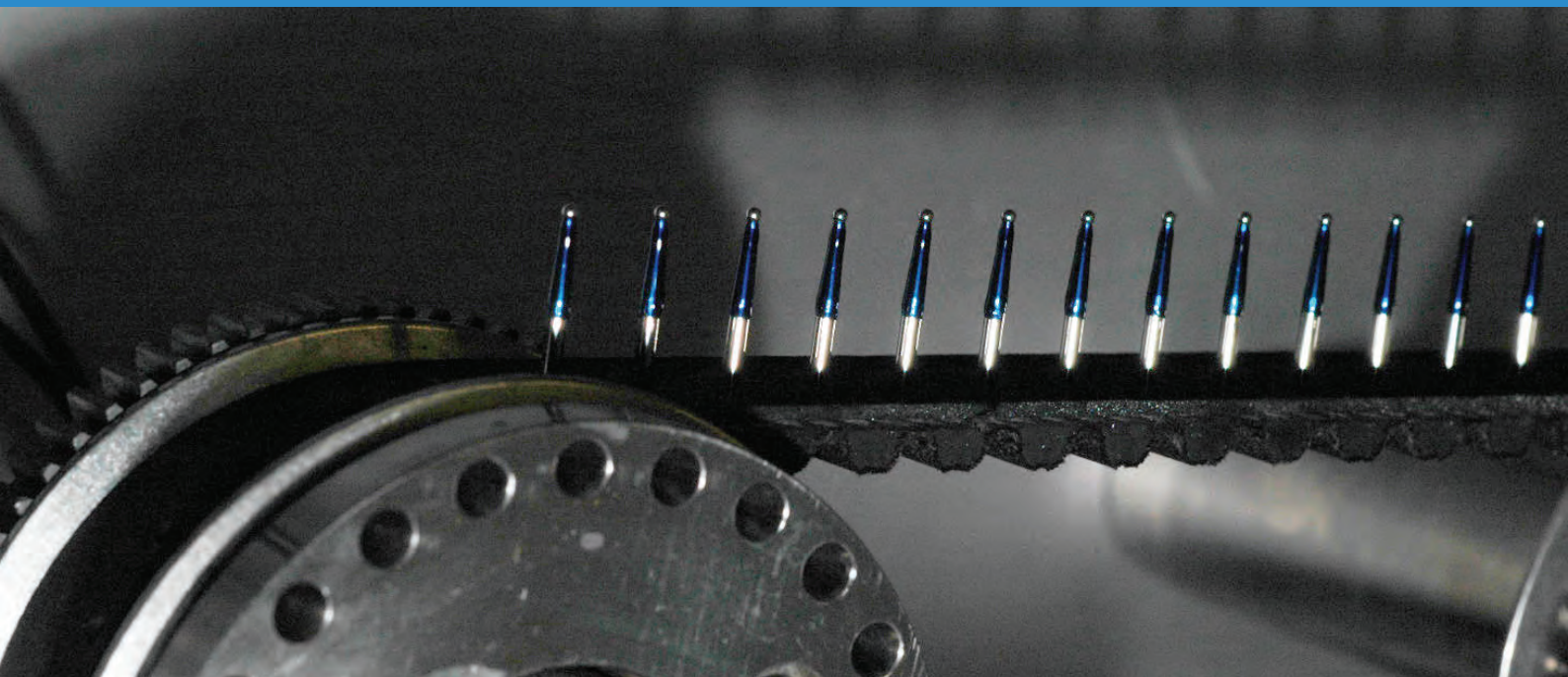
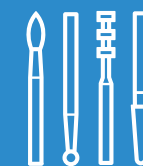

Uno strumento essenziale in Odontoiatria

Le frese dentali occupano un luogo importante negli strumenti di base dell'Odontoiatria. La loro corretta scelta e adattamento allo strumento rotatorio determinerà la loro efficacia a lungo termine.

Molto frequentemente, questi strumenti sono scelti in modo empirico. Lo studio delle diverse sostanze e materiali su cui si lavora e i risultati di diversi studi clinici, permettono di scegliere le frese che meglio si adattano.

Norme di utilizzo

- Assicurare una refrigerazione sufficiente mediante spray d'acqua per evitare il deterioramento del dente e del suo ambiente.
- Lo spray deve essere distribuito su tutta la longitudine attiva dello strumento. Una deviazione del getto può provocare lesioni di origine termica.
- È necessaria una refrigerazione aggiuntiva per strumenti con una longitudine superiore a 19 mm o con un diametro della parte attiva superiore a 2 mm.
- Ritirare immediatamente gli strumenti rotti, così come gli strumenti piegati o eccentrici.
- Prendere in considerazione la pressione di lavoro prescritta di 0,3 - 2N (30 - 200p) per strumenti FG e 2 - 5N (200-500p) per strumenti HP, lavorare senza pressione.
- Le turbine, contrangoli e strumenti manuali devono essere in perfette condizioni per il buon funzionamento del materiale.

- Inserire gli strumenti con attenzione e senza forzarli nella modalità di allenamento. Gli strumenti devono essere introdotti nelle pinze fino alla parte cilindrica finale.
- Durante il lavoro, evitare di forzare e inclinare lo strumento e girarlo sul bordo.
- Rispettare assolutamente le velocità di rotazione raccomandate indicate nell'imballaggio.
- Portare lo strumento alla sua velocità di rotazione raccomandata fuori dalla bocca del paziente (in modo tale che l'odontotecnico possa portare la rotazione alla velocità massima prima di applicare lo strumento all'oggetto da lavorare).
- Qualsiasi strumento usurato o danneggiato deve essere smaltito secondo le norme di smaltimento dei rifiuti in vigore nel Paese d'uso.
- Qualsiasi incidente grave che possa prodursi in relazione allo strumento dovrà essere comunicato al fabbricante e/o all'autorità competente dello Stato membro in cui è stabilito l'utente.

»»» Gamma di frese



Studio



Laboratorio

DIAMANTATE

- Standard
- Serie R-RD
- Micropreparazione
- Veneers
- Punta guida
- Diamanti DLC
- Multistrati
- Parodontologia
- Interdentale



IN LABORATORIO

- Diamantati
- Carburo di tungsteno
- Pulidores
- Diversos



CARBURO DI TUNGSTENO

- Standard
- Escavazione
- Ponti e corone
- Finitura 12 lame
- Finitura 30 lame
- Endodonzia
- Chirurgiche



CERAMICA

- Ceramica per tessuti molli



LUCIDATORI

- Spazzole
- Universale
- Composito
- Ceramica
- Pietra



Aplicaciones



Chirurgia maxillo-facciale



Profilassi



Impiantologia



Eliminazione di vecchi restauri



Ortodonzia



Separazione della corona



Preparazione di corone



Levigatura radicolare



Preparazione della cavità



Trattamento di otturazioni



Preparazione del canale radicolare



Le principali caratteristiche delle frese sono:

- La scelta rigorosa del materiale con cui sono realizzate.
- La precisione e il rigore della fabbricazione.
- L'efficacia e la comodità del prodotto quando lavora.
- La durata di vita dello strumento a medio lungo termine.

AXIS
dental
SWISS QUALITY



FRESE DENTALI

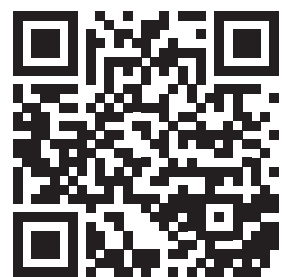
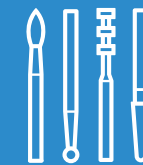

Nel nostro sito WEB troverai tutti i nostri riferimenti di frese con informazioni dettagliate per poter scegliere i prodotti che si adeguano alle necessità del professionista.

VISITA TRAMITE IL QR.

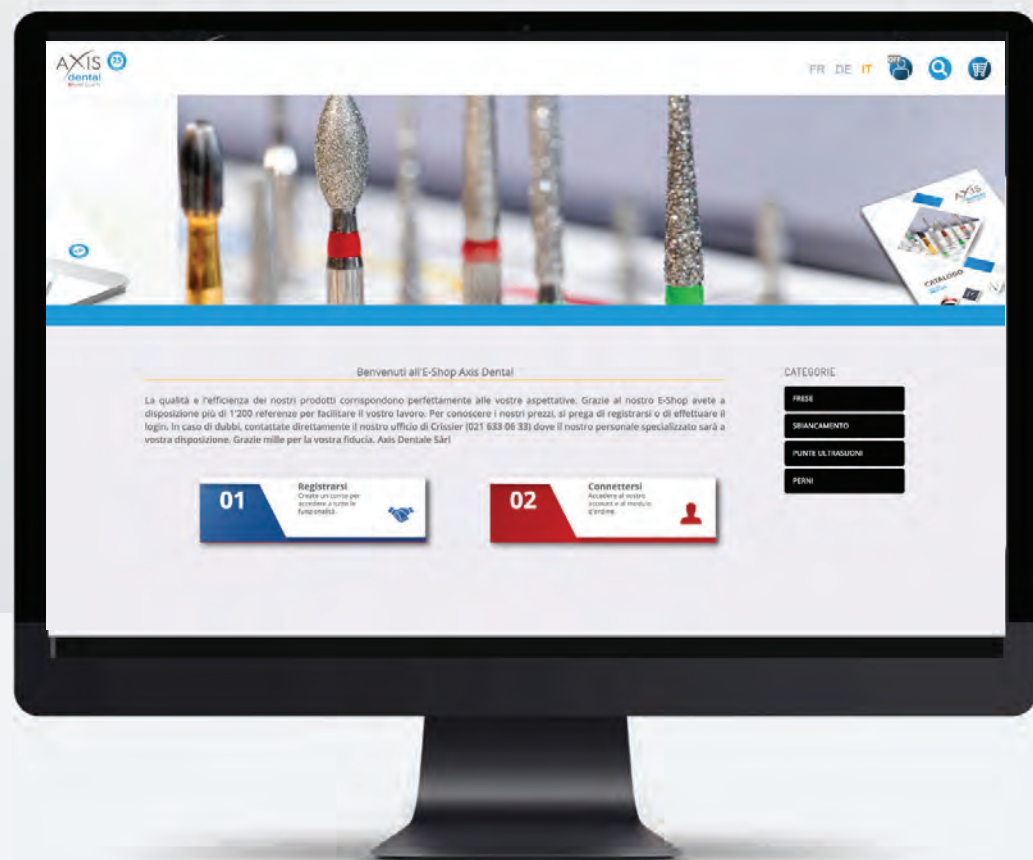

VISITA IL NOSTRO SITO

WEB

Come realizzare l'ordine

801

L mm	0.8	0.9	1	1.2	1.4	1.6	1.8	2.1	2.3	2.7	2.9	3.5	
806.314.001.524	FG 801	008	009	010	012	014	016	018	021	023	027	029	035
806.314.001.504	FG C 801	X	X	X	012	014	X	X	X	023	X	029	X
806.314.001.514	FG F 801	X	009	010	012	014	016	018	021	023	027	029	035
806.314.001.534	FG G 801	X	009	010	012	014	016	018	021	023	027	029	035
806.314.001.544	FG SG 801	X	X	X	012	014	016	018	021	023	X	X	X
806.313.001.524	FG S 801	X	009	010	012	014	016	X	X	X	X	X	X
806.204.001.524	RA 801	X	X	X	012	014	016	018	X	023	X	029	X

1 Con il riferimento Axis

Aggiungendo il diametro al riferimento Axis indicato.

FG F 801.014

2 Tramite il nostro e-shop

Selezionando direttamente il diametro desiderato della punta nell'e-shop. Il sistema automaticamente suggerirà il riferimento Axis.

FG G 801.027

3 Con il numero ISO

Aggiungendo il diametro del numero ISO indicato

806.313.001.524.010



FRESE DENTALI



Studio

AXIS
dental
SWISS QUALITY

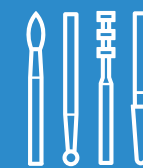

DIAMANTATE

CARBURO DI TUNGSTENO CERAMICA LUCIDATRICI

- Standard
- Series R-RD
- Micropreparazione
- Veneers
- Punta guida
- Diamanti DLC
- Multistrati
- Parodontologia
- Interdentale

Axis Dental ha progettato una nuova generazione di strumento, una fresa unica con un 20% in più di rivestimento di DIAMANTE.



Introduzione alle frese diamante

Gli strumenti di diamante hanno un manico in acciaio inossidabile ad alta resistenza alla deformazione (monoblocco). È perfettamente calibrato per avere un movimento di rotazione pura.

Sopra la parte attiva della fresa viene fissato il diamante che si unisce all'acciaio nudo mediante un processo speciale di elettrodeposizione in tre fasi:

- Una placca di preparazione di Nichel che ha una funzione antivibrazione.
- Una placca di aggancio, che unisce i granelli di diamante in modo sicuro.
- Una placca dura di Nichel che fissa con forza i granelli di diamante.

Possono essere fabbricati con particelle di diamante naturale o sintetico. Prendendo in considerazione la superiorità delle particelle di diamante naturale, Axis Dental fabbrica unicamente i propri prodotti con questa opzione.

Le proprietà fisiche del diamante naturale sono le seguenti:

- La sua gran durata.
- La sua gran purezza.
- La sua forma.
- La sua struttura.

La parte attiva della fresa è ricoperta di granelli calibrati di diamante naturale. La grande capacità abrasiva di questa superficie, associata all'alta velocità di rotazione, permette un effetto di abrasione molto efficace delle strutture dure del dente (smalto e dentina sana).

Tuttavia, non è efficace per togliere struttura dentale morbida (dentina cariata).



Modo d'uso:

- La fresa viene fissata su una turbina o un contrangolo ad alta velocità.
- Questi apparecchi hanno a disposizione un sistema di refrigerazione ad acqua e aria.
- La rotazione della fresa e la misura delle particelle di diamante varia secondo il desiderio di efficacia richiesto.
- Grazie alla sua alta efficacia, gli strumenti di diamante grossi e super grossi si utilizzano per realizzare qualsiasi tipo di preparazione dentale senza aumentare la temperatura.
- Le frese standard sono di particelle di grano medio, permettendo una buona abrasione e un taglio sottile.
- Gli strumenti di diamante di finitura possiedono un grano fino che permette un lavoro più preciso allo stesso modo che si ottiene una superficie perfettamente liscia.

Il potere del
diamante



FRESE DENTALI



Studio

AXIS
dental
SWISS QUALITY

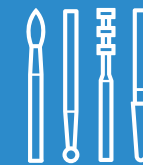

DIAMANTATE CARBURO DI TUNGSTENO CERAMICA LUCIDATRICI

Composizione Del Numero ISO

(ISO 6360, 2157, 1797)

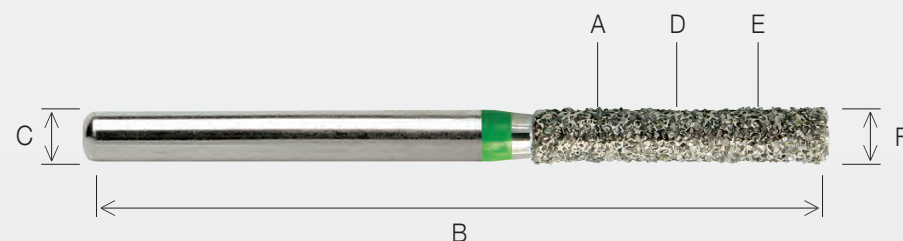

A + B C + D + E + F = ISO-No. 806.314.111.534.012

- | | |
|---|---|
| <p>A Materia della parte attiva.
Esempio: 806 diamante / 500 carburo di tungsteno, ecc.</p> <p>B / C Manico e lunghezza totale.
Esempio: 314 FG / 204 RA, ecc.</p> <p>D Forma della parte attiva.
Esempio: 111 cilindro, 001 arrotondata, ecc.</p> | <p>E Tipo di finitura della parte attiva.
Esempio: 534 granelli di diamante grossi, 007 fogli elicoidali con tagli trasversali, ecc.</p> <p>F Misura nominale, diametro della parte attiva più grande in scala 1 / 10 mm.
Esempio: 012 diametro 0.12 mm, ecc.</p> |
|---|---|



Corrispondenza ISO con il riferimento di Axis Dental

ISO-No. 806.314.111.534.012



ISO	AXIS DENTAL
806	Diamante
314	FG
111	837
534	G
012	012

Manici di frese dentali

Diametri: 1.60 mm

Per ogni tipo di turbine o contrangoli ad alta velocità (rosso)

ISO 313 FG S (Friction Grip Short)

- Misura del manico L: 16 mm
- Quando l'altezza del lavoro è limitata, un manico più piccolo permette un accesso più comodo.

ISO 314 FG (Friction Grip)

- Misura del manico L: 19 mm
- È il manico più frequente.

ISO 315 FG L (Friction Grip Long)

- Misura del manico L: 21 mm

ISO 316 FG XL (Friction Grip Xtra Long)

- Misura del manico L: 25 mm
- La misura di questo manico permette la chirurgia

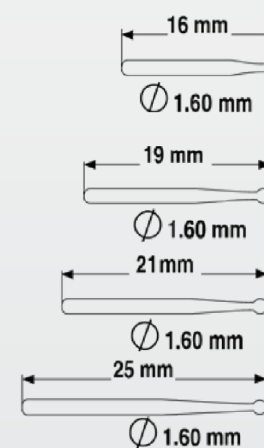

Diametro: 2.35 mm

Per ogni tipo di contrangoli di bassa velocità (blu o verde)

ISO 204 RA (Right Angle)

- Misura del manico L: 22 mm

ISO 205 RA L (Right Angle Long)

- Misura del manico L: 26 mm

ISO 206 RA XL (Right Angle Xtra Long)

- Misura del manico L: 36 mm

Per l'uso in strumenti manuali

ISO 104 HP (Hand Piece)

- Misura del manico L: 44.5 mm



Foto fornite da BienAir.

AXIS
dental
SWISS QUALITY



FRESE DENTALI

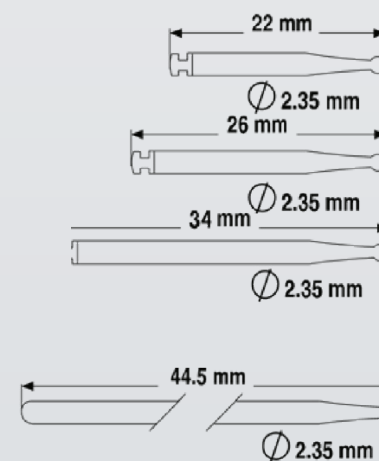

Studio

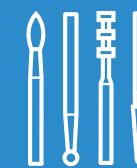

DIAMANTATE

CARBURO DI TUNGSTENO

CERAMICA

LUCIDATRICI



Caratteristiche delle Frese Diamante

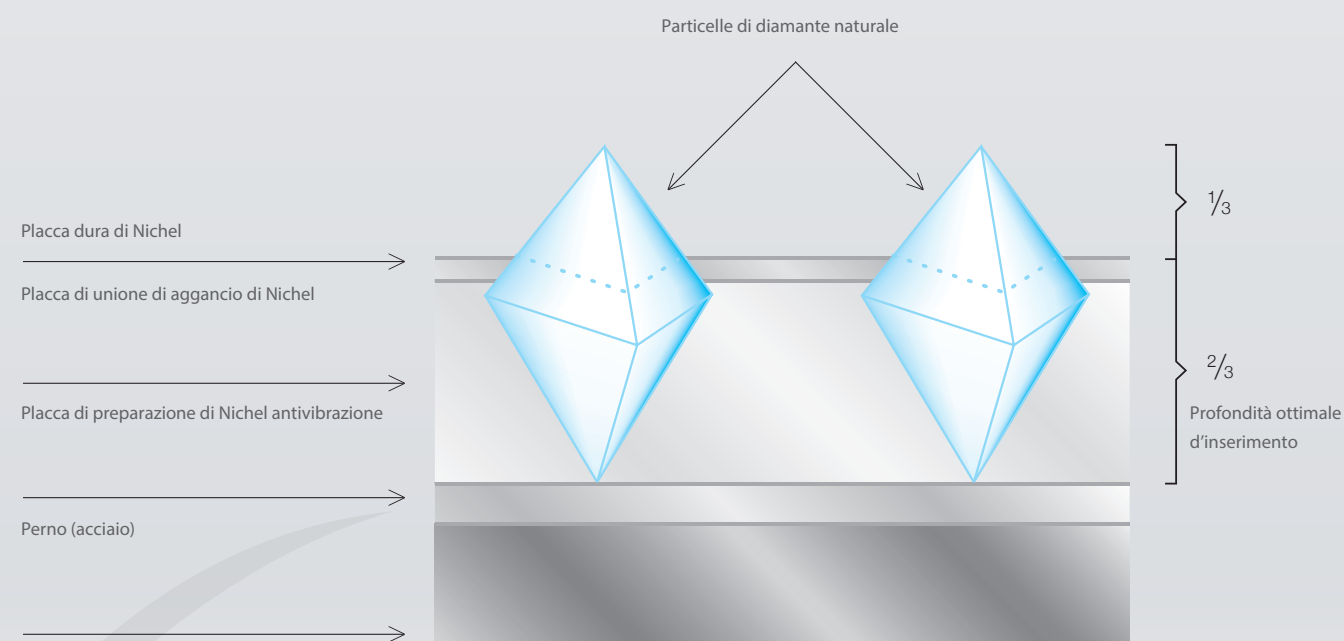

1

DUREZZA

Il diamante naturale è il minerale più duro del pianeta.

Peso specifico	3.514
Massa molecolare	12.01
Durezza	10 MOHS= 8000 H.V

3

FORMA

La forma ottaedrica delle particelle di diamante naturale permette un'alta densità di diamante e degli spazi intermolecolari regolari. Entrambe le caratteristiche sono necessarie per un'ottimale eliminazione di residui di taglio.

La concentrazione ottenuta è tra il 50 e il 60% della superficie, mentre la concentrazione teorica ottimale ottenuta con sfere è del 75%.

Le particelle di diamante devono essere calibrate per assicurare una concentrazione ottimale e regolare sullo strumento. La distribuzione equitativa garantisce una rotazione concentrica della fresa perfetta.

2

PUREZZA

Le particelle di diamante naturale non hanno praticamente nessuna impurezza magnetica come il nichel, il cobalto o il ferro.

Uno studio di De Beers paragona la purezza del diamante naturale con quello sintetico.

Comparazione tra diamanti naturali e sintetici		
	Diamante naturale	Diamante sintetico, particolarmente trattato con elettrodeposizione
Impurezze di Ferro Ppm	10-50	1000-7000
Suscettibilità magnetica X 10-6 cgs	0-4	110-170

4

STRUTTURA SUPERFICIALE

La superficie irregolare delle particelle di diamante naturale gli conferisce effetti ritentivi molto buoni nella placca di adesione di nichel e migliora il comportamento abrasivo grazie ai suoi bordi di taglio affilati.

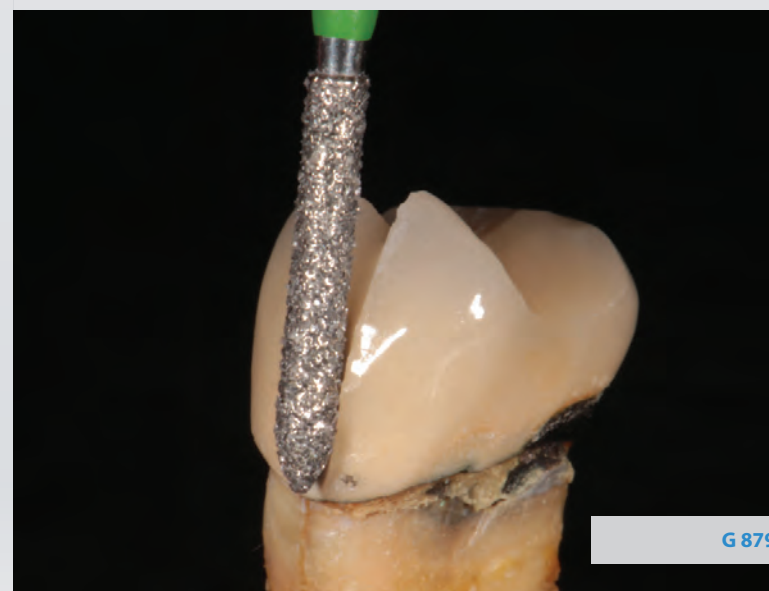

G 879



FRESE DENTALI



DIAMANTATE

CARBURO DI TUNGSTENO

CERAMICA

LUCIDATRICI

Le particelle di diamante calibrate si distribuiscono principalmente in cinque misure diverse.



Super Grossa (SG)
– ANELLO NERO
Misura del granello di diamante ~ 150-180µ

- Lo strumento più abrasivo del mercato.
- L'efficienza è superiore di un 60% rispetto a una fresa standard.
- Sopportano alta pressione di taglio con una grande capacità di abrasione

Grossa (G)–
ANELLO VERDE
Misura del granello di diamante ~ 125-150 µ

- Uno strumento relativamente abrasivo.
- L'efficienza è di un 30% superiore rispetto a una fresa standard.
- Sopportano alta pressione di taglio con una grande capacità di abrasione.

Standard–
SENZA ANELLO
Misura del granello di diamante ~ 106 µ

Buona capacità di abrasione.

Sottile (F)–
ANELLO ROSSO
Misura del granello di diamante ~45µ

Morbidezza della superficie trattata con una buona finitura.

Extra Sottili (C) –
ANELLO GIALLO
Misura del granello di diamante ~ 15µ

- Morbidezza della superficie trattata con una buona finitura.
- Applicazione ideale sui compositi.

Vita media della capacità di abrasione degli strumenti di diamante basata nei materiali e sostanze trattate

La vita media di abrasione degli strumenti di diamante dipende dal lavoro svolto e dal modo in cui vengono usati. La loro usura proviene dallo staccarsi delle particelle di diamante.

La vita media degli strumenti può diminuire con un uso scorretto.



- Lo smalto causa un'usura normale.
- La dentina sana, i cementi e i compositi alterano minimamente lo strumento.
- L'amalgama e l'oro, più che usare lo strumento, ostruiscono lo spazio tra le particelle di diamante.
- L'acciaio, il cromo-nichel e il cromo-cobalto alterano rapidamente lo strumento.
- La punta di un perno di acciaio incluso nel restauro può danneggiare la superficie abrasiva dello strumento.



FRESE DENTALI



Studio

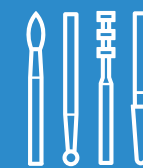

DIAMANTATE

CARBURO DI TUNGSTENO CERAMICA LUCIDATRICI

STANDARD

- Series R-RD
- Micropreparazione
- Veneers
- Punta guida
- Diamanti DLC
- Multistrati
- Parodontologia
- Interdentale

STANDARD

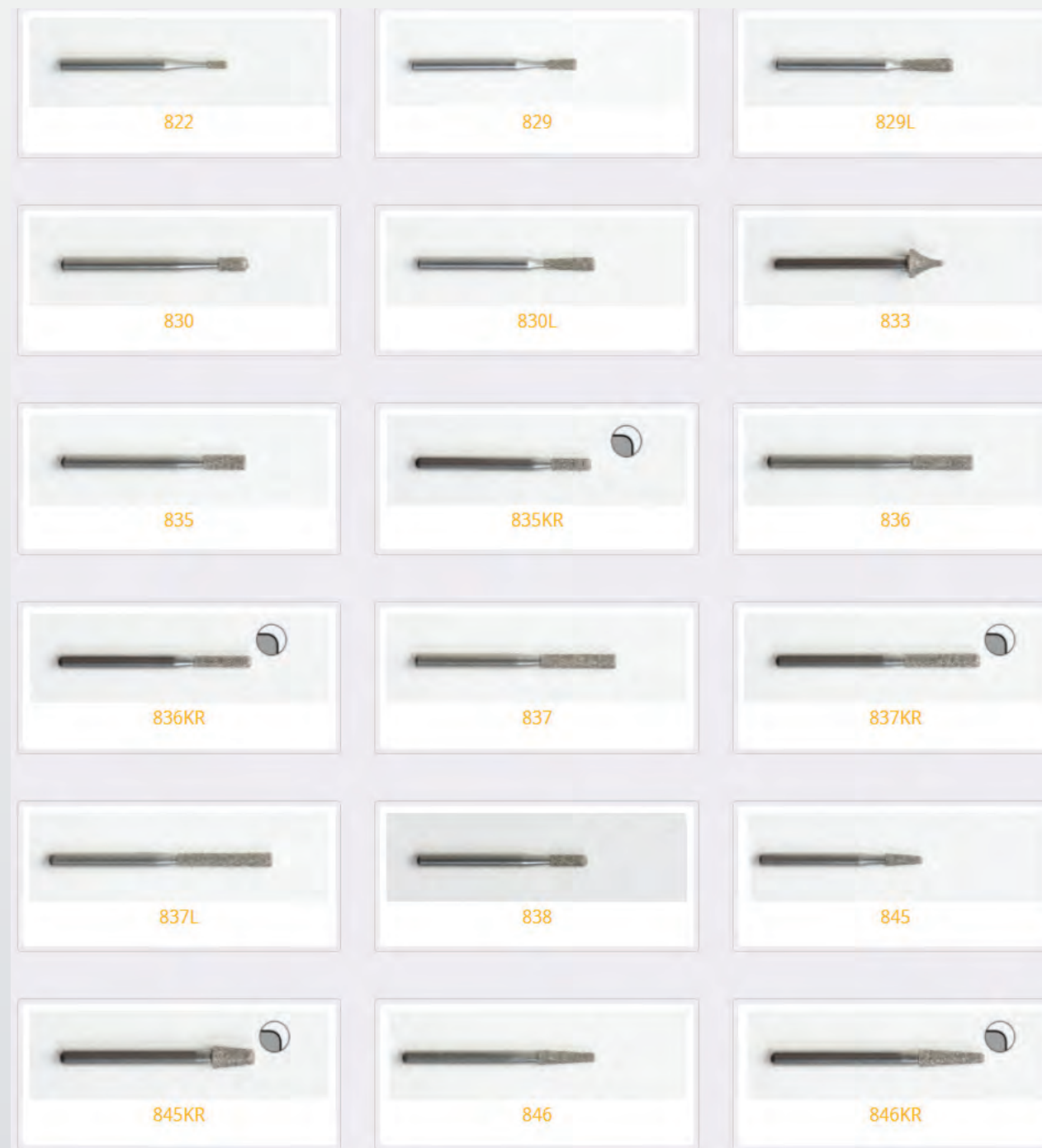
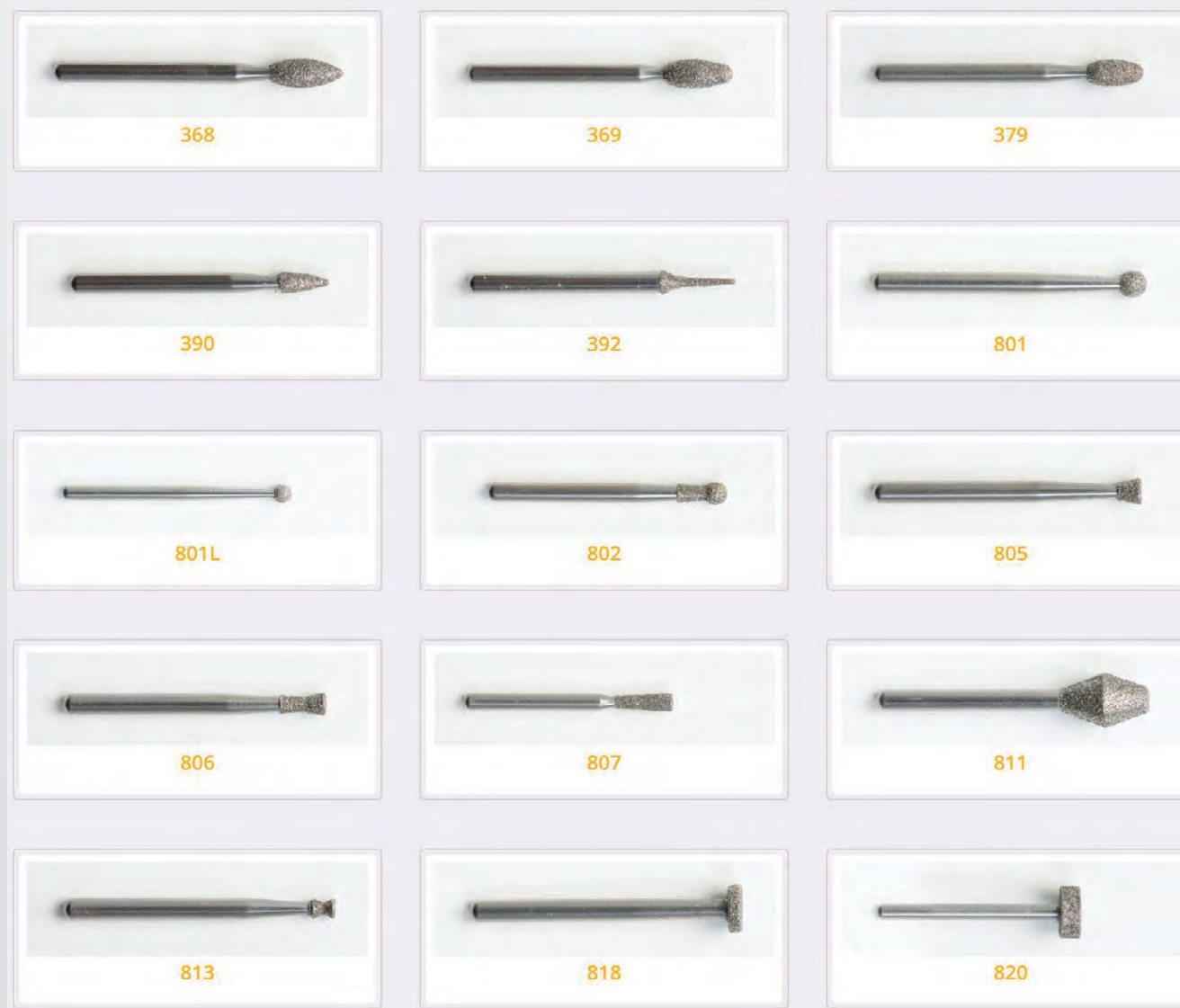



FRESE DENTALI



Studio

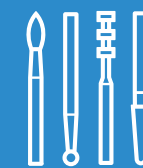

DIAMANTATE CARBURO DI TUNGSTENO CERAMICA LUCIDATRICI

- STANDARD
- Series R-RD
- Micropreparazione
- Veneers
- Punta guida
- Diamanti DLC
- Multistrati
- Parodontologia
- Interdentale

STANDARD

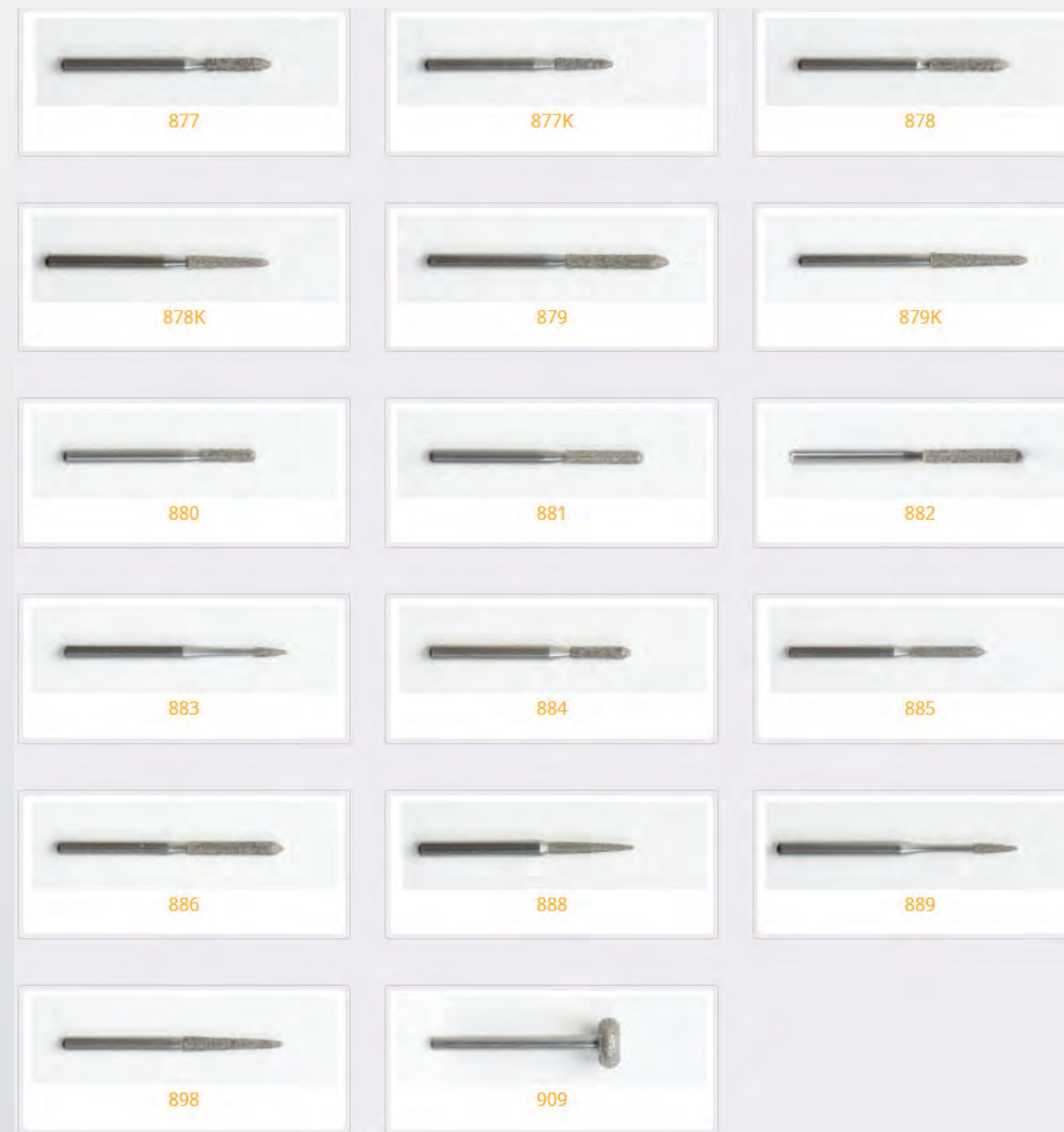



FRESE DENTALI



Studio

AXIS
dental
SWISS QUALITY

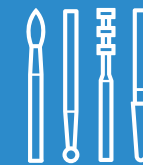

DIAMANTATE

CARBURO DI TUNGSTENO CERAMICA LUCIDATRICI

STANDARD

- Series R-RD
- Micropreparazione
- Veneers
- Punta guida
- Diamanti DLC
- Multistrati
- Parodontologia
- Interdentale

368



L mm

3.5 3.5 5 5

	806.314.257.524.	FG 368.	016	018	021	023
	806.314.257.504.	FG C 368.	016	018	021	023
	806.314.257.514.	FG F 368.	016	018	021	023
	806.314.257.534.	FG G 368.	016	018	021	023
	806.314.257.544.	FG SG 368.	016	018	021	023



	806.313.257.524.	FG S 368.	016	X	X	023
--	------------------	-----------	-----	---	---	-----



	806.204.257.524.	RA 368.	X	X	X	023
	806.204.257.514.	RAF 368.	X	X	X	023

369



L mm

5.5

	806.314.263.524.023	FG 369.	023
	806.314.263.504.023	FG C 369.	023
	806.314.263.514.023	FG F 369.	023
	806.314.263.534.023	FG G 369.	023
	806.314.263.544.023	FG SG 369.	023

379



L mm

3 3.5 4.5 4.5

	806.314.277.524.	FG 379.	014	018	021	023
	806.314.277.504.	FG C 379.	014	018	021	023
	806.314.277.514.	FG F 379.	014	018	021	023
	806.314.277.534.	FG G 379.	014	018	021	023
	806.314.277.544.	FG SG 379.	X	018	021	023



FRESE DENTALI



Studio

AXIS
dental
SWISS QUALITY

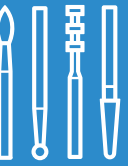

DIAMANTATE

CARBURO DI TUNGSTENO CERAMICA LUCIDATRICI

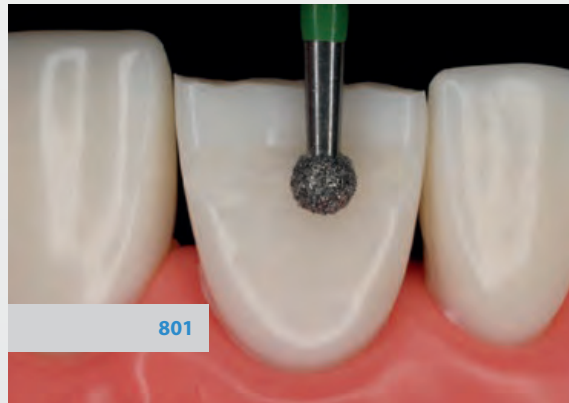

STANDARD

- Series R-RD
- Micropreparazione
- Veneers
- Punta guida
- Diamanti DLC
- Multistrati
- Parodontologia
- Interdentale





390









 L mm 3.5



	806.314.274.524.016	FG 390.	016
	806.314.274.504.316	FG C 390.	016
	806.314.274.514.016	FG F 390.	016

392









 L mm 5



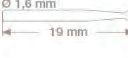

	806.314.465.524.016	FG 392.	016
	806.314.465.504.016	FG C 392.	016
	806.314.465.514.016	FG F 392.	016

801









 L mm 0.8 0.9 1 1.2 1.4 1.6 1.8 2.1 2.3 2.7 2.9 3.5

	806.314.001.524.	FG 801.	008	009	010	012	014	016	018	021	023	027	029	035
	806.314.001.504.	FG C 801.	X	X	X	012	014	X	X	X	023	X	029	X
	806.314.001.514.	FG F 801.	X	009	010	012	014	016	018	021	023	027	029	035
	806.314.001.534.	FG G 801.	X	009	010	012	014	016	018	021	023	027	029	035
	806.314.001.544.	FG SG 801.	X	X	X	012	014	016	018	021	023	X	X	*



 L mm 0.8 0.9 1 1.2 1.4 1.6 1.8 2.1 2.3 2.7 2.9 3.5



	806.313.001.524.	FG S 801.	X	009	010	012	014	016	X	X	X	X	X	X
--	------------------	-----------	---	-----	-----	-----	-----	-----	---	---	---	---	---	---



 L mm 0.8 0.9 1 1.2 1.4 1.6 1.8 2.1 2.3 2.7 2.9 3.5





	806.204.001.524.	RA 801.	X	X	X	012	014	016	018	X	023	X	029	X
---	------------------	---------	---	---	---	-----	-----	-----	-----	---	-----	---	-----	---

801L



 L mm 1 1.2 1.4 1.6 1.8

	806.314.697.524.	FG 801L.	010	012	014	016	018
	806.314.697.514.	FG F 801L.	X	X	X	016	X
	806.314.697.534.	FG G 801L.	010	012	014	016	018
	806.314.697.544.	FG SG 801L.	X	012	014	016	018



FRESE DENTALI



Studio

AXIS
dental
SWISS QUALITY

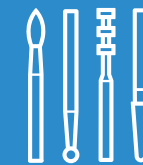



DIAMANTATE

CARBURO DI TUNGSTENO CERAMICA LUCIDATRICI

STANDARD



- Series R-RD
- Micropreparazione
- Veneers
- Punta guida
- Diamanti DLC
- Multistrati
- Parodontologia
- Interdentale

802





L mm 2.5 3 3 3 3.5





	806.314.002.524.	FG 802.	010	012	014	016	018
	806.314.002.514.	FG F 802.	×	012	×	×	×
	806.314.002.534.	FG G 802.	010	012	014	016	×

805



L mm 1 1 1.2 1.5 1.5 1.5 2



	806.314.010.524.	FG 805.	009	010	012	014	016	018	023
	806.314.010.534.	FG G 805.	×	010	012	014	016	018	×



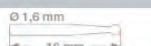

806.313.010.524. FG S 805. × 010 012 × × × ×

806.204.010.524. RA 805. × × 012 014 × × ×





806





L mm 2 3 3 3 3





	806.314.019.524.	FG 806.	010	012	014	016	018
	806.314.019.534.	FG G 806.	010	012	014	016	018

807

L mm 3.5 4 5



	806.314.225.524.	FG 807.	012	016	018
	806.314.225.534.	FG G 807.	012	016	018

811





L mm 4 6





	806.314.038.524.	FG 811.	033	040
	806.314.038.544.	FG SG 811.	033	040

813

L mm 1.5 1.6



	806.314.032.524.	FG 813.	010	014
	806.314.032.534.	FG G 813.	×	014



FRESE DENTALI



Studio

AXIS
dental
SWISS QUALITY

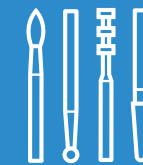



DIAMANTATE

CARBURO DI TUNGSTENO CERAMICA LUCIDATRICI

STANDARD

- Series R-RD
- Micropreparazione
- Veneers
- Punta guida
- Diamanti DLC
- Multistrati
- Parodontologia
- Interdentale



818

L mm	0.5	1	1
------	-----	---	---

806.314.042.524.	FG 818.	018	033	042
806.314.042.534.	FG G 818.	X	X	042

820

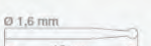
L mm	2
------	---

806.314.043.524.050	FG 820.	050
---------------------	---------	-----

822





L mm	2
------	---

806.314.237.524.009	FG 822.	009
---------------------	---------	-----

829







L mm	3	3
------	---	---

806.314.235.524.	FG 829.	010	012
806.314.235.504.	FG C 829.	010	012
806.314.235.514.	FG F 829.	010	012

829L

L mm	5
------	---

806.314.236.524.04	FG 829L.	014
806.314.236.504.014	FG C 829L.	014
806.314.236.514.014	FG F 829L.	014



FRESE DENTALI



Studio

AXIS
dental
SWISS QUALITY

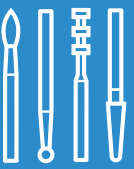

DIAMANTATE CARBURO DI TUNGSTENO CERAMICA LUCIDATRICI



830

830

	L mm	3	3	3	3
806.314.238.524.	FG 830.	009	010	012	014
806.314.238.504.	FG C 830.	X	010	012	X
806.314.238.514.	FG F 830.	X	010	012	014
806.314.238.534.	FG G 830.	X	010	012	014
806.314.238.544.	FG SG 830.	X	X	012	014
<hr/>					
806.313.238.524.	FG S 830.	X	010	012	X

830L

	L mm	4	5	5	5
806.314.239.524.	FG 830L.	012	014	016	018
806.314.239.504.	FG C 830L.	012	014	X	X
806.314.239.514.	FG F 830L.	012	014	016	018
806.314.239.534.	FG G 830L.	012	014	016	018
806.314.239.544.	FG SG 830L.	X	014	X	X

833

	L mm	3.5	
806.314.466.524.031	FG 833.	031	
806.314.466.514.031	FG F 833.	031	



FRESE DENTALI



Studio

AXIS
dental
SWISS QUALITY

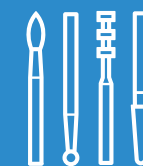

DIAMANTATE

CARBURO DI TUNGSTENO CERAMICA LUCIDATRICI

STANDARD

- Series R-RD
- Micropreparazione
- Veneers
- Punta guida
- Diamanti DLC
- Multistrati
- Parodontologia
- Interdentale

835

L mm	3	3	4	4	4	5	
806.314.107.524.	FG 835.	008	009	010	012	014	016
806.314.107.504.	FG C 835.	008	X	X	X	X	X
806.314.107.514.	FG F 835.	008	X	X	X	X	X
806.314.107.534.	FG G 835.	008	009	010	012	014	016
806.314.107.544.	FG SG 835.	X	X	010	012	014	X

L mm	3	4	4	4	5		
806.313.107.524.	FG S 835.	008	X	010	012	X	X

L mm	3	4	4	4	5		
806.204.107.524.	RA 835.	X	X	X	012	X	X

835KR

L mm	3	4	4	4	5	
806.314.156.524.	FG 835KR.	008	010	012	014	016
806.314.156.514.	FG F 835KR.	008	010	012	014	016
806.314.156.534.	FG G 835KR.	008	010	012	014	016

836

L mm	6	6	6	6	
806.314.110.524.	FG 836.	010	012	014	018
806.314.110.504.	FG C 836.	X	012	X	X
806.314.110.514.	FG F 836.	010	012	014	X
806.314.110.534.	FG G 836.	010	012	014	018
806.314.110.544.	FG SG 836.	X	012	014	X

L mm	6	6	6	6	
806.313.110.524.	FG S 836.	X	012	X	X

836KR

L mm	6	6	6	6	6	
806.314.157.524.	FG 836KR.	010	012	014	016	018
806.314.157.514.	FG F 836KR.	X	012	X	016	X
806.314.157.534.	FG G 836KR.	010	X	X	X	X
806.314.157.544.	FG SG 836KR.	010	X	X	X	X



FRESE DENTALI



Studio

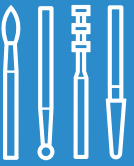

DIAMANTATE

CARBURO DI TUNGSTENO CERAMICA LUCIDATRICI

STANDARD

- Series R-RD
- Micropreparazione
- Veneers
- Punta guida
- Diamanti DLC
- Multistrati
- Parodontologia
- Interdentale

837

	L mm	7	8	8	8	8
806.314.111.524.	FG 837.	010	012	014	016	018
806.314.111.514.	FG F 837.	010	012	014	X	X
806.314.111.534.	FG G 837.	010	012	014	016	018
806.314.111.544.	FG SG 837.	010	012	014	X	X
<hr/>						
806.313.111.524.	FG S 837.	X	012	X	X	X
<hr/>						
806.204.111.524.	RA 837.	X	X	014	X	X

837KR

	L mm	8	8	8
806.314.158.524.	FG 837KR.	012	014	016
806.314.158.514.	FG F 837KR.	012	014	016
806.314.158.534.	FG G 837KR.	012	014	016



837L

	L mm	10	10	10	10
806.314.112.524.	FG 837L.	012	014	016	018
806.314.112.514.	FG F 837L.	012	014	X	X
806.314.112.534.	FG G 837L.	012	014	016	018



FRESE DENTALI



Studio

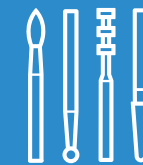

DIAMANTATE

CARBURO DI TUNGSTENO



CERAMICA







LUCIDATRICI

STANDARD



- Series R-RD
- Micropreparazione
- Veneers
- Punta guida
- Diamanti DLC
- Multistrati
- Parodontologia
- Interdentale







838

	L mm	3	4	4
 				
	806.314.137.524.	FG 838.	008 010 012	
	806.314.137.514.	FG F 838.	X X 012	
	806.314.137.534.	FG G 838.	X 010 012	
	806.314.137.544.	FG SG 838.	X 010 012	





845



	L mm	4	4	4
  				
	806.314.170.524.	FG 845.	012 014 018	
	806.314.170.514.	FG F 845.	012 X X	
	806.314.170.534.	FG G 845.	012 014 X	
	806.314.170.544.	FG SG 845.	012 X X	







845KR





	L mm	4	4	4
  				
	806.314.544.524.	FG 845KR.	018 021 025	
	806.314.544.514.	FG F 845KR.	018 021 025	

846

	L mm	6	6	7
  				
	806.314.171.524.	FG 846.	012 016 025	
	806.314.171.514.	FG F 846.	X 016 025	
	806.314.171.534.	FG G 846.	012 016 025	
	806.314.171.544.	FG SG 846.	X 016 X	



	806.313.171.524.	FG S 846.	X 016 X	
---	------------------	-----------	---------	--



FRESE DENTALI



Studio

AXIS
dental
SWISS QUALITY

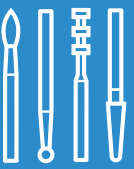

DIAMANTATE





CARBURO DI TUNGSTENO CERAMICA LUCIDATRICI

STANDARD

- Series R-RD
- Micropreparazione
- Veneers
- Punta guida
- Diamanti DLC
- Multistrati
- Parodontologia
- Interdentale





846KR

Ø 1,6 mm
19 mm

	L mm	6	6	6
 806.314.545.524.	FG 846KR.	014	016	018
 806.314.545.514.	FG F 846KR.	×	016	018
 806.314.545.534.	FG G 846KR.	014	016	×
 806.314.545.544.	FG SG 846KR.	014	016	×





847

Ø 1,6 mm
19 mm

	L mm	8	8	8	8	8
 806.314.172.524.	FG 847.	012	014	016	018	021
 806.314.172.514.	FG F 847.	012	×	×	018	021
 806.314.172.534.	FG G 847.	012	014	016	018	021
 806.314.172.544.	FG SG 847.	012	014	016	018	021
 806.313.172.524.	FG S 847.	×	014	×	×	×





847KR

Ø 1,6 mm
19 mm

	L mm	8	8	8	8
 806.314.546.524.	FG 847KR.	014	016	018	023
 806.314.546.514.	FG F 847KR.	×	×	018	023
 806.314.546.534.	FG G 847KR.	×	×	018	023
 806.314.546.544.	FG SG 847KR.	×	×	018	×

848

Ø 1,6 mm
19 mm

	L mm	10	10	10	10	10
 806.314.173.524.	FG 848.	012	014	016	018	025
 806.314.173.504.	FG C 848.	×	×	016	×	×
 806.314.173.514.	FG F 848.	012	014	016	×	×
 806.314.173.534.	FG G 848.	012	014	016	018	025
 806.314.173.544.	FG SG 848.	012	014	016	018	×



FRESE DENTALI



Studio

AXIS
dental
SWISS QUALITY

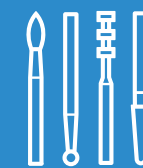

DIAMANTATE

CARBURO DI TUNGSTENO CERAMICA LUCIDATRICI

STANDARD

- Series R-RD
- Micropreparazione
- Veneers
- Punta guida
- Diamanti DLC
- Multistrati
- Parodontologia
- Interdentale

849

Diagram showing diameter $\varnothing 1,6 \text{ mm}$ and length 19 mm.

	L mm	4	4
	806.314.196.524.	FG 849.	010 012
	806.314.196.514.	FG F 849.	010 012
	806.314.196.534.	FG G 849.	010 012

850

Diagram showing diameter $\varnothing 1,6 \text{ mm}$ and length 19 mm.

	L mm	10	10	10	10	10	10
	806.314.199.524.	FG 850.	012	014	016	018	021 023
	806.314.199.504.	FG C 850.	012	014	016	X	X X
	806.314.199.514.	FG F 850.	012	014	016	018	021 023
	806.314.199.534.	FG G 850.	012	014	016	018	021 023
	806.314.199.544.	FG SG 850.	012	014	016	018	021 023
	806.204.199.524.	RA 850.	X	014	X	X	X X

850XL

Diagram showing diameter $\varnothing 1,6 \text{ mm}$ and length 19 mm.

	L mm	10	
	806.314.199XL.524.012.	FG 850XL.	012
	806.314.199XL.514.012.	FG F 850XL.	012
	806.314.199XL.534.012.	FG G 850XL.	012
	806.314.199XL.544.012.	FG SG 850XL.	012

851

Diagram showing diameter $\varnothing 1,6 \text{ mm}$ and length 19 mm.

	L mm	8	8
	806.314.219.524.	FG 851.	012 016
	806.314.219.534.	FG G 851.	012 016



FRESE DENTALI



Studio

AXIS
dental
SWISS QUALITY

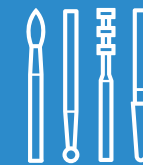



DIAMANTATE

CARBURO DI TUNGSTENO CERAMICA LUCIDATRICI

STANDARD





- Series R-RD
- Micropreparazione
- Veneers
- Punta guida
- Diamanti DLC
- Multistrati
- Parodontologia
- Interdentale

852





L mm 4 6 6



	806.314.164.524.	FG 852.	010	012	016
	806.314.164.504.	FG C 852.	010	012	016
	806.314.164.514.	FG F 852.	010	012	016
	806.314.164.534.	FG G 852.	X	012	016



	806.313.164.524.	FG S 852.	010	X	X
---	------------------	-----------	-----	---	---

855





L mm 6 6







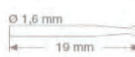

	806.314.197.524.	FG 855.	012	014
	806.314.197.514.	FG F 855.	012	X
	806.314.197.534.	FG G 855.	012	014

856





L mm 8 8 8 8 8 8



	806.314.198.524.	FG 856.	012	014	016	018	021	023
	806.314.198.504.	FG C 856.	012	014	016	X	X	X
	806.314.198.514.	FG F 856.	012	X	016	018	021	023
	806.314.198.534.	FG G 856.	012	014	016	018	021	023
	806.314.198.544.	FG SG 856.	012	014	016	018	021	023



	806.313.198.524.	FG S 856.	X	014	016	X	X	X
--	------------------	-----------	---	-----	-----	---	---	---



FRESE DENTALI



Studio

AXIS
dental
SWISS QUALITY

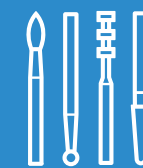



DIAMANTATE

CARBURO DI TUNGSTENO CERAMICA LUCIDATRICI

STANDARD



- Series R-RD
- Micropreparazione
- Veneers
- Punta guida
- Diamanti DLC
- Multistrati
- Parodontologia
- Interdentale

858

	L mm	8	8	8	8
806.314.165.524.	FG 858.	012	014	016	018
806.314.165.504.	FG C 858.	012	014	016	X
806.314.165.514.	FG F 858.	012	014	016	X
806.314.165.534.	FG G 858.	012	014	016	018
806.314.165.544.	FG SG 858.	X	014	X	X
806.313.165.524.	FG S 858.	X	014	X	X



859

	L mm	10	10	10	10	10
806.314.166.524.	FG 859.	010	012	014	016	018
806.314.166.504.	FG C 859.	010	012	014	016	018
806.314.166.514.	FG F 859.	010	012	014	016	018
806.314.166.534.	FG G 859.	010	012	014	016	018
806.314.166.544.	FG SG 859.	X	X	X	018	018
806.313.166.524.	FG S 859.	010	X	X	016	X
806.204.166.524.	RA 859.	X	012	X	016	X



860

	L mm	4	5
806.314.247.524.	FG 860.	010	012
806.314.247.504.	FG C 860.	010	012
806.314.247.514.	FG F 860.	010	012
806.314.247.534.	FG G 860.	010	012
806.204.247.524.	RA 860.	X	012

861



	L mm	7
806.314.248.524.012	FG 861.	012
806.314.248.504.012	FG C 861.	012
806.314.248.514.012	FG F 861.	012



FRESE DENTALI



Studio

AXIS
dental
SWISS QUALITY

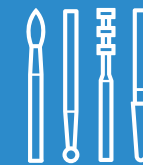



DIAMANTATE

CARBURO DI TUNGSTENO CERAMICA LUCIDATRICI





STANDARD

- Series R-RD
- Micropreparazione
- Veneers
- Punta guida
- Diamanti DLC
- Multistrati
- Parodontologia
- Interdentale

862







 L mm 8 8 8 8

	806.314.249.524.	FG 862.	010	012	014	016
	806.314.249.504.	FG C 862.	010	012	014	016
	806.314.249.514.	FG F 862.	010	012	014	016
	806.314.249.534.	FG G 862.	010	012	014	016
	806.314.249.544.	FG SG 862.	X	012	014	016



 L mm 16

	806.313.249.524.	FG S 862.	X	012	X	X
--	------------------	-----------	---	-----	---	---







 L mm 22

	806.204.249.524.	RA 862.	X	012	X	X
	806.204.249.514.	RA F 862.	X	012	X	X

863



 L mm 10 10 10

	806.314.250.524.	FG 863.	012	016	018
	806.314.250.504.	FG C 863.	012	016	X
	806.314.250.514.	FG F 863.	012	016	018
	806.314.250.534.	FG G 863.	012	016	018
	806.314.250.544.	FG SG 863.	012	016	X

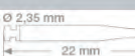

 L mm 22

	806.204.250.524.	RA 863.	X	X	018
---	------------------	---------	---	---	-----



864











 L mm 12

	806.314.251.524.014	FG 864.	014
	806.314.251.534.014	FG G 864.	014

868K

 L mm 8 8

	806.314.222.524.	FG 868K.	012	016
	806.314.222.504.	FG C 868K.	X	016
	806.314.222.514.	FG F 868K.	012	016
	806.314.222.534.	FG G 868K.	012	016
	806.314.222.544.	FG SG 868K.	012	016



FRESE DENTALI



Studio

AXIS
dental
SWISS QUALITY

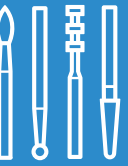

DIAMANTATE

CARBURO DI TUNGSTENO

CERAMICA

LUCIDATRICI

STANDARD

- Series R-RD
- Micropreparazione
- Veneers
- Punta guida
- Diamanti DLC
- Multistrati
- Parodontologia
- Interdentale

877



L mm 6 6



	806.314.288.524.	FG 877.	010	012
	806.314.288.504.	FG C 877.	010	X
	806.314.288.514.	FG F 877.	010	012
	806.314.288.534.	FG G 877.	010	012
	806.314.288.544.	FG SG 877.	010	012

	806.313.288.524.	FG S 877.	010	X
--	------------------	-----------	-----	---

877K



L mm 6 6



	806.314.297.524.	FG 877K.	014	016
	806.314.297.544.	FG SG 877K.	014	016

878



L mm 8 8 8 8



	806.314.289.524.	FG 878.	010	012	014	016
	806.314.289.504.	FG C 878.	010	X	X	X
	806.314.289.514.	FG F 878.	010	012	014	016
	806.314.289.534.	FG G 878.	010	012	014	016
	806.314.289.544.	FG SG 878.	010	012	014	016

	806.313.289.524.	FG S 878.	X	X	014	X
--	------------------	-----------	---	---	-----	---

878K



L mm 8 8 8 8 8



	806.314.298.524.	FG 878K.	012	014	016	018	021
	806.314.298.514.	FG F 878K.	012	014	016	018	021
	806.314.298.534.	FG G 878K.	012	014	016	018	021
	806.314.298.544.	FG SG 878K.	X	014	016	018	021



FRESE DENTALI



Studio

AXIS
dental
SWISS QUALITY

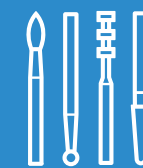



DIAMANTATE

CARBURO DI TUNGSTENO CERAMICA LUCIDATRICI

STANDARD



- Series R-RD
- Micropreparazione
- Veneers
- Punta guida
- Diamanti DLC
- Multistrati
- Parodontologia
- Interdentale

882



L mm	10	10	10
806.314.142.524.	FG 882.	010	012 014
806.314.142.514.	FG F 882.	010	012 014
806.314.142.534.	FG G 882.	010	012 014
806.314.142.544.	FG SG 882.	010	012 014

883



L mm	3
806.314.142.524.010	FG 883. 010
806.314.142.514.010	FG F 883. 010
806.314.142.534.010	FG G 883. 010

884

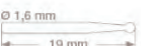

L mm	6
806.314.129.524.012	FG 884. 012
806.314.129.514.012	FG F 884. 012
806.314.129.534.012	FG G 884. 012
806.313.129.524.012	FG S 884. 012

885

L mm	8
806.314.130.524.	FG 885. 012
806.314.130.514.	FG F 885. 012
806.314.130.534.	FG G 885. 012
806.314.130.544.	FG SG 885. 012

886

L mm	10	10	10
806.314.131.524.	FG 886.	012	014 016
806.314.131.504.	FG C 886.	012	X X
806.314.131.514.	FG F 886.	012	014 016
806.314.131.534.	FG G 886.	012	014 016
806.314.131.544.	FG SG 886.	012	X X



FRESE DENTALI



Studio

AXIS
dental
SWISS QUALITY

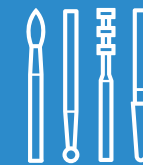



DIAMANTATE

CARBURO DI TUNGSTENO CERAMICA LUCIDATRICI

STANDARD



- Series R-RD
- Micropreparazione
- Veneers
- Punta guida
- Diamanti DLC
- Multistrati
- Parodontologia
- Interdentale







888

		L mm	8
	806.314.496.524.012	FG 888.	012
	806.314.496.534.012	FG G 888.	012

889



		L mm	3.5	4
	806.314.540.524.	FG 889.	009	010
	806.314.540.504.	FG C 889.	009	X
	806.314.540.514.	FG F 889.	009	010
	806.314.540.534.	FG G 889.	009	010
				
	806.313.540.524.	FG S 889.	009	X







898



		L mm	10.5
	806.314.213.524.016	FG 898.	016
	806.314.213.534.016	FG G 898.	016

909

		L mm	1	1.5	2.1
	806.314.068.524.	FG 909.	033	042	050
	806.314.068.534.	FG G 909.	033	042	X
	806.314.068.544.	FG SG 909.	X	042	X
					
	806.313.068.524.	FG S 909.	X	042	X
					
	806.204.068.524.	RA 909.	033	X	X



FRESE DENTALI



Studio

AXIS
dental
SWISS QUALITY

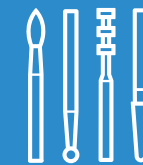

DIAMANTATE

CARBURO DI TUNGSTENO

CERAMICA

LUCIDATRICI

- Standard
- SERIES R-RD**
- Micropreparazione
- Veneers
- Punta guida
- Diamanti DLC
- Multistrati
- Parodontologia
- Interdentale

SERIES R-RD



R837



R847



R848



RD837



RD848

R837

L mm 7 10

806.314.R111.524. FG R837. 014 018

R847

L mm 7

806.314.R172.524.016 FG R847. 016

R848

L mm 10 10

806.314.R173.524. FG R848. 018 025

RD837

L mm 10

806.314.RD111.524.016 FG RD837. 016

RD848

L mm 10

806.314.RD173.524.016 FG RD848. 016



FRESE DENTALI



Studio

AXIS
dental
SWISS QUALITY

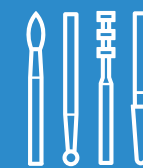

DIAMANTATE CARBURO DI TUNGSTENO CERAMICA LUCIDATRICI

- Standard
- Series R-RD
- MICROPREPARAZIONE**
- Veneers
- Punta guida
- Diamanti DLC
- Multistrati
- Parodontologia
- Interdentale

MICROPREPARAZIONE



830M

L mm 2.7

	806.314..524.	FG 830M.	012
	806.314..514.	FG F 830M.	012

830RM

L mm 2.7

	806.314..524.	FG 830RM.	009
	806.314..514.	FG F 830RM.	009

838M

L mm 2.7

	806.314..524.	FG 838M.	007
	806.314..514.	FG F 838M.	007

889M

L mm 2.7

	806.314..524.	FG 889M.	007
	806.314..514.	FG F 889M.	007



FRESE DENTALI



Studio

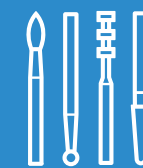

DIAMANTATE

CARBURO DI TUNGSTENO CERAMICA LUCIDATRICE

- Standard
- Series R-RD
- MICROPREPARAZIONE**
- Veneers
- Punta guida
- Diamanti DLC
- Multistrati
- Parodontologia
- Interdentale



953AM

	806.314.524.	FG 953AM.	014
	806.314.514.	FG F 953AM.	014

953M

	806.314.524.	FG 953M.	014
	806.314.514.	FG F 953M.	014

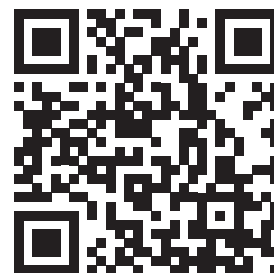

Nel nostro sito WEB troverai tutti i nostri riferimenti di frese con informazioni dettagliate per poter scegliere i prodotti adeguati alle necessità del professionista.

VISITA TRAMITE IL QR.

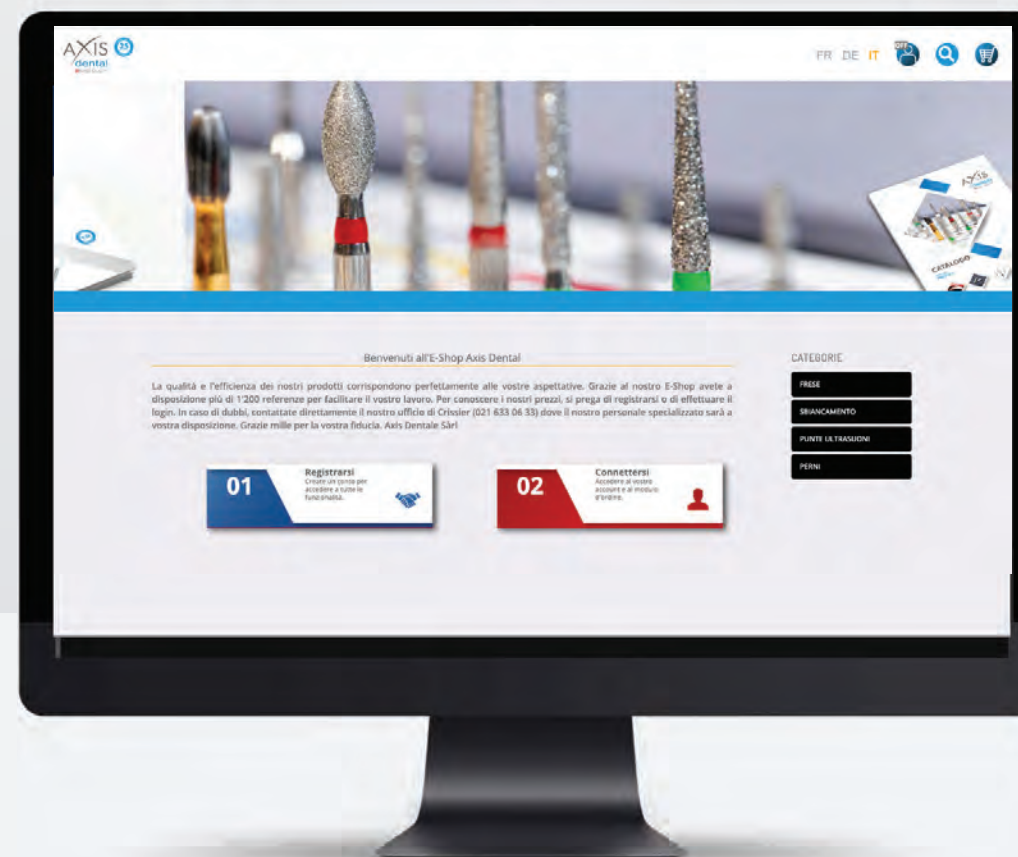

VISITA IL NOSTRO SITO

WEB



FRESE DENTALI



Studio

AXIS
dental
SWISS QUALITY

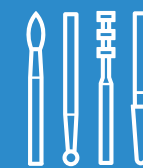

DIAMANTATE CARBURO DI TUNGSTENO CERAMICA LUCIDATRICI

- Standard
- Series R-RD
- Micropreparazione
- VENEERS**
- Punta guida
- Diamanti DLC
- Multistrati
- Parodontologia
- Interdentale

VENEERS



834

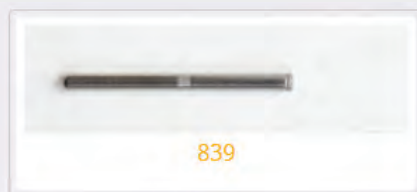

839



GF 844

834

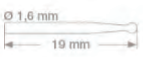
	035	045	055
L mm	6	6	6

806.314.552.524

FG 834 016 018 021

839





L mm	0.2	0.2	0.2

806.314.150.524

FG 839 012 014 016

Preparazione per le veneers

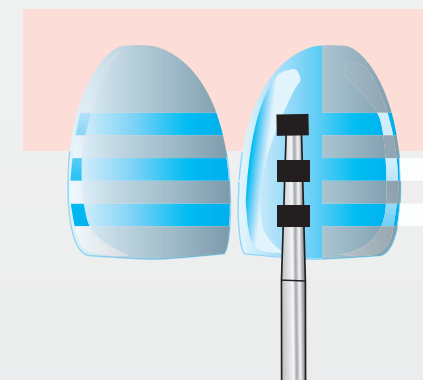
I canali guida definiscono la quantità massima di tessuto che ritiriamo, determinando così il livello della preparazione definitiva. La più piccola (016) crea profondità di 0.3 mm negli incisivi centrali e nei canini, mentre che la misura di testa più lunga (021) crea profondità di 0.5 mm negli incisivi laterali. Con la 850/016 riduciamo la struttura vestibolare del dente alla profondità determinata.



GF844



L mm	10	10

G & F on tip

FG GF844 014 016



FRESE DENTALI



Studio

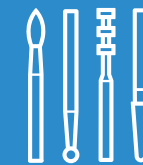

DIAMANTATE

CARBURO DI TUNGSTENO CERAMICA LUCIDATRICI

- Standard
- Series R-RD
- Micropreparazione
- Veneers
- PUNTA GUIDA**
- Diamanti DLC
- Multistrati
- Parodontologia
- Interdentale

Con l'appoggio di una guida all'estremità, questa fresa garantisce una larghezza identica e controllata sui 360 gradi del taglio della corona.

PUNTA GUIDA

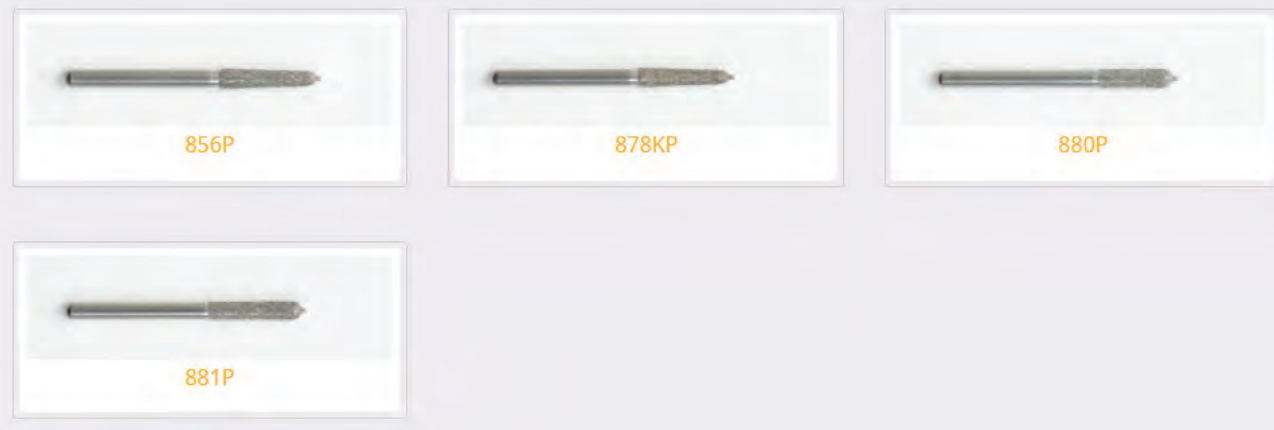

856P

L mm 8 8

806.314.524. FG 856P 018 021

878KP

L mm 8 8

806.314.524. FG 878KP 018 021

880P

L mm 6

806.314.524.018 FG 880P 018

881P

L mm 9

806.314.524.018 FG 881P 018



FRESE DENTALI



Studio

AXIS
dental
SWISS QUALITY

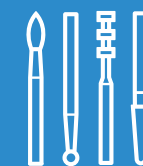

DIAMANTATE

CARBURO DI TUNGSTENO CERAMICA LUCIDATRICI

- Standard
- Series R-RD
- Micropreparazione
- Veneers
- Punta guida
- DIAMANTI DLC**
- Multistrati
- Parodontologia
- Interdentale

Frese di diamante con trattamento superficiale DLC (Diamond-like Carbon) che conferisce una durata ineguagliabile.

DIAMANTI DLC



DLC801



L mm 1,4

DLC806.314.001.534. FG G DLC801. 014

DLC837



L mm 8

DLC806.314.111.535. FG G DLC837. 014

DLC856



L mm 8

DLC806.314.198.535. FG G DLC856. 018

DLC880



L mm 6

DLC806.314.140.536. FG G DLC880. 012

DLC881



L mm 8 8

DLC806.314.141.536. FG G DLC881. 012 014



FRESE DENTALI



Studio

AXIS
dental
SWISS QUALITY

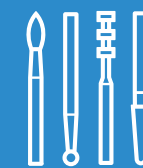

DIAMANTATE

CARBURO DI TUNGSTENO CERAMICA LUCIDATRICI

- Standard
- Series R-RD
- Micropreparazione
- Veneers
- Punta guida
- Diamanti DLC
- MULTISTRATI**
- Parodontologia
- Interdentale

Seguendo gli ultimi progressi tecnologici, la gamma multiplacca di frese di diamante si compone di 2 tipi di granelli, che permette di lavorare con esse sulla materia più resistente e allunga la vita della fresa.

MULTISTRATI

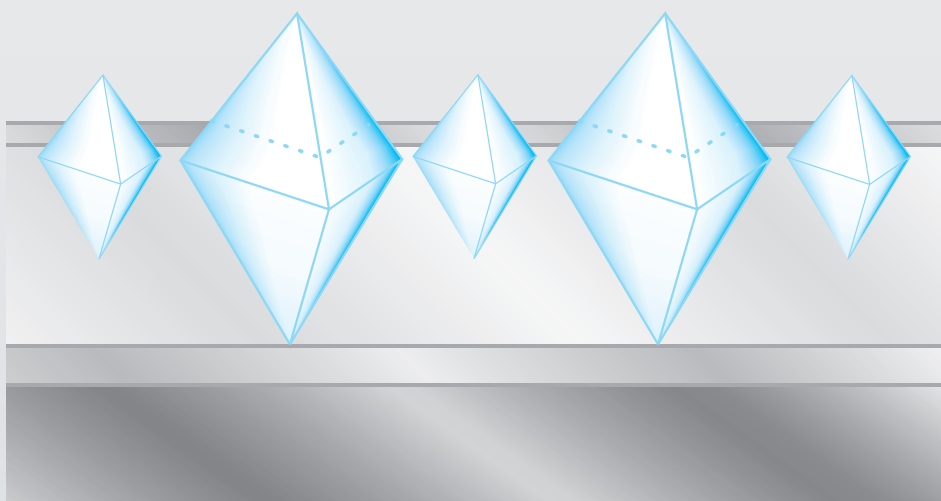

Z379

Ø 1,6 mm
19 mm

L mm	3.5	4.5
FG Z379	018	023
FG C Z379	✘	023
FG F Z379	018	✘

Z801L



L mm 1.2 1.8

FG Z801L	012	018
FG F Z801L	012	018

Z850

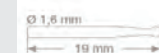

L mm 10

FG Z850	018
FG C Z850	018
FG F Z850	018
FG G Z850	018

Z862



L mm 8

FG Z862	016
FG C Z862	016
FG F Z862	016



FRESE DENTALI



Studio

AXIS
dental
SWISS QUALITY

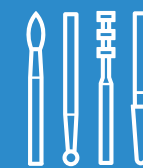

DIAMANTATE

CARBURO DI TUNGSTENO CERAMICA LUCIDATRICI

- Standard
- Series R-RD
- Micropreparazione
- Veneers
- Punta guida
- Diamanti DLC
- Multistrati
- PARODONTOLOGIA**
- Interdentale

Le frese di diamante per Parodontologia dispongono di un manico più lungo e su fissazione di contrangolo; in questo modo si garantisce il successo dei trattamenti effettuati con le stesse.

PARODONTOLOGIA



P368L



P368XL



P868L



P868XL

P368L

Technical specifications for P368L:

- Length (L mm): 5
- Shaft diameter: Ø 2,35 mm
- Shaft length: 22 mm
- Part number: 806.204.524
- RA P368L: 014
- RA F P368L: 014
- RA C P368L: 014

P368XL

Technical specifications for P368XL:

- Length (L mm): 5
- Shaft diameter: Ø 2,35 mm
- Shaft length: 22 mm
- Part number: 806.204.524
- RA P368XL: 014
- RA F P368XL: 014
- RA C P368XL: 014

P868L

Technical specifications for P868L:

- Length (L mm): 7
- Shaft diameter: Ø 2,35 mm
- Shaft length: 22 mm
- Part number: 806.204.524
- RA P868L: 014
- RA F P868L: 014
- RA C P868L: 014

P868XL

Technical specifications for P868XL:

- Length (L mm): 7
- Shaft diameter: Ø 2,35 mm
- Shaft length: 22 mm
- Part number: 806.204.524
- RA P868XL: 014
- RA F P868XL: 014
- RA C P868XL: 014



FRESE DENTALI



Studio

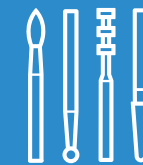

DIAMANTATE

CARBURO DI TUNGSTENO CERAMICA LUCIDATRICI

- Standard
- Series R-RD
- Micropreparazione
- Veneers
- Punta guida
- Diamanti DLC
- Multistrati
- Parodontologia
- INTERDENTALE**

Frese Interdentali di diamanti hanno bisogno di un contrangolo EVA.

INTERDENTALE



ORTHO







PROXO

ORTHO





L mm 4

	6 Åµm / Å° 0.12	XF ORTHO
	15 Åµm / Å° 0.14	UF ORTHO
	25 Åµm / Å° 0.16	C ORTHO
	45 Åµm / Å° 0.26	F ORTHO

PROXO



	25 Åµm	C PROXO
	45 Åµm	F PROXO
	60 Åµm	PROXO
	90 Åµm	G PROXO



Nel nostro sito WEB troverai tutti i nostri riferimenti di frese con informazioni dettagliate per poter scegliere i prodotti adeguati alle necessità del professionista.

VISITA TRAMITE IL QR.

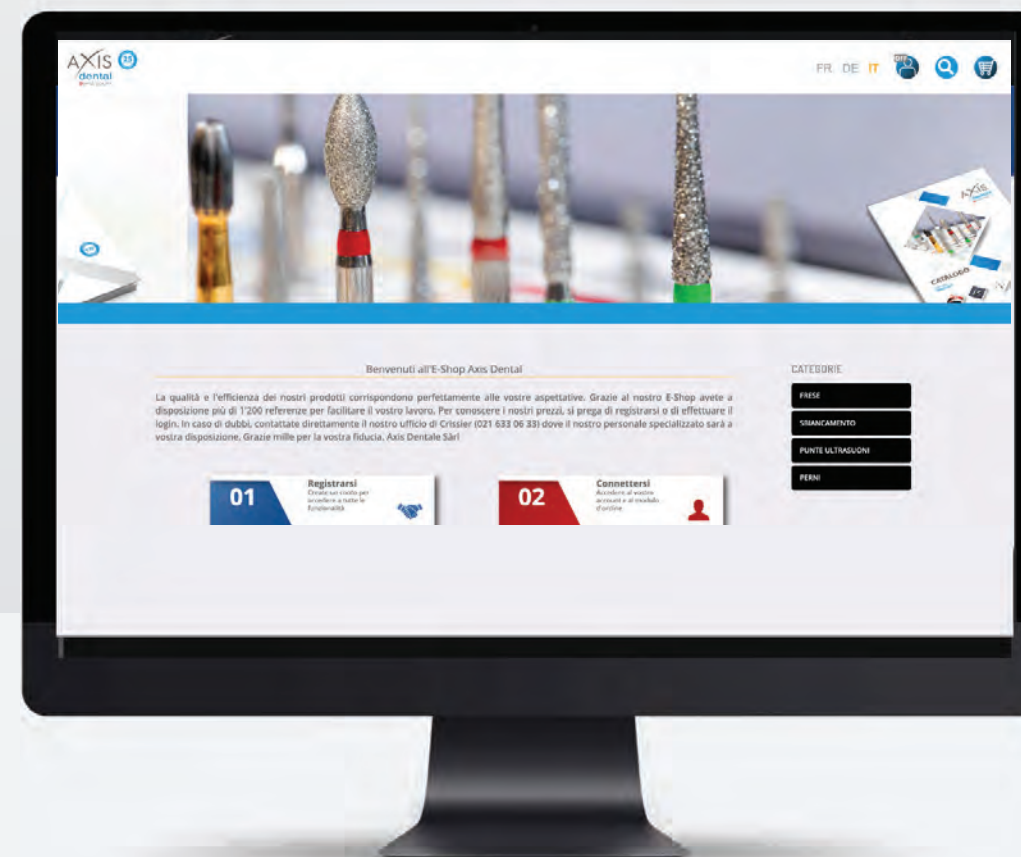

VISITA IL NOSTRO SITO

WEB



FRESE DENTALI



Studio

AXIS
dental
SWISS QUALITY

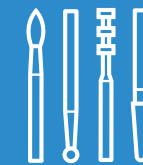

DIAMANTATE CARBURO DI TUNGSTENO

CERAMICA LUCIDATRICI

- Standard
- Escavazione
- Ponti e corone
- Finitura 12 lame
- Finitura 30 lame
- Endodonzia
- Chirurgiche

Lo sviluppo di un design innovativo per risolvere tutti i problemi che esistevano con il carburo di tungsteno è stato uno dei grandi successi di Axis Dental.



1 ELIMINAZIONE DI CARIE

Efficace e comoda.

Queste frese permettono di tagliare lo smalto senza dover utilizzare previamente una fresa di diamante.

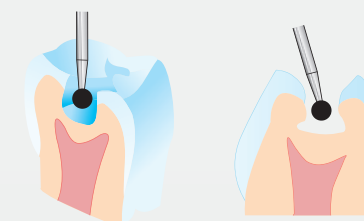

2 RITIRATA DI RESTAURI MORBIDI (amalgame, compositi, cementi)

Sicura e funzionale

Queste gamme offrono 2 opzioni che si adattano al tuo modo di lavorare.

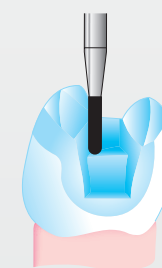

3 RITIRATA DI RESTAURI METALLICI

Qualità e potenza

Una lega speciale di carburo che riesce a tagliare il metallo in modo molto efficiente.

4 CORONE E PONTI

Carburo speciale con lamine incrociate per avere un miglior controllo e comodità sulla fresa.

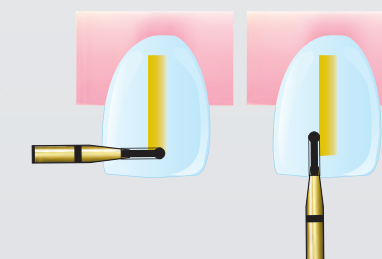

5 ODONTOSEZIONE

Perfetta capacità di taglio con un controllo e una sicurezza ottimale.

Il carburo è 10 volte più efficace dell'acciaio.

AXIS
dental
SWISS QUALITY



FRESE DENTALI



Studio

AXIS
dental
SWISS QUALITY

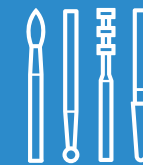

DIAMANTATE CARBURO DI TUNGSTENO

CERAMICA LUCIDATRICI

Grazie alle caratteristiche del carburo di tungsteno selezionato da Axis Dental, l'effetto del taglio delle nostre frese è molte volte superiore rispetto a una fresa d'acciaio standard.



La punta attiva di queste frese di carburo tungsteno risolve 6 problemi per l'odontoiatra:

- Evita lo scontro nel momento del contatto con la materia.
- Con la nostra lamina esclusiva, la fresa entra soavemente nella materia senza trovare resistenza e/o scontro.
- Elimina le vibrazioni durante il lavoro.
- È una fresa comoda e gradevole per lavorare dove il professionista ha un controllo totale della fresa durante l'intervento.
- Evita la rottura della parte attiva della fresa.
- Non provoca disallineamenti innessari della turbina prevenendo costose revisioni.

Le frese di carburo di tungsteno sono il miglior strumento per il lavoro sulle materie morbide, per diversi motivi:

- Sono più efficaci in questo tipo di situazioni.
- Riescono a lasciare la superficie di cui il professionista ha bisogno, liscia o ritentiva, a seconda del trattamento.
- Riducono il tempo di intervento del professionista.
- I metalli richiedono un'attenzione specifica in modo che non venga scaldata la zona dell'intervento e scomodare il paziente. Le frese di carburo di tungsteno di Axis Dental hanno una qualità superiore e un design speciale che garantiscono il successo totale in questo trattamento.
- Axis Dental propone sempre la miglior selezione di ogni fresa per ogni tipo di attività.

Strumenti di carburo di tungsteno

La parte attiva è fatta di fogli il cui profilo permette un effetto di taglio efficace associato all'eliminazione di residui.

- I fogli sono elicoidali.
- I fogli possono presentare tagli trasversali che formano piccole fessure.
- La quantità di fogli e lo spazio tra essi può aumentare o diminuire in funzione del proposito del lavoro.
- Pochi fogli separati tra di loro produrranno una buona efficacia di taglio e un efficace ritirata di residui, in cambio di una maggior fragilità e vibrazione.
- Un gran numero di fogli molto uniti tra di loro produrranno un lento e preciso lavoro di finitura senza vibrazione con una minore efficacia di taglio e una minor produzione di calore.

Modo d'uso:

- Montata su una turbina o un contrangolo ad alta velocità per fresare strutture dentali dure.
- Montata su un contrangolo a bassa velocità per una riduzione della cavità, espulsione di tessuti morbidi, dentina cariata...

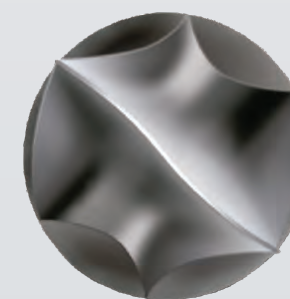

Estremità attiva garantendo comodità ed efficacia

Le frese tonde di Axis Dental si distinguono con una lamina trasversale attiva nella loro estremità consentendo un lavoro senza colpi e con assenza di vibrazioni.

L'efficacia del taglio delle frese di carburo di tungsteno di Axis Dental permette di lavorare in modo semplice su superfici sia rugose sia lisce e sempre con la miglior qualità.



FRESE DENTALI



Studio

AXIS
dental
SWISS QUALITY

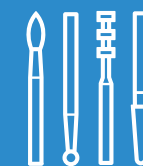

DIAMANTATE CARBURO DI TUNGSTENO CERAMICA LUCIDATRICI

STANDARD

- Escavazione
- Ponti e corone
- Finitura 12 lame
- Finitura 30 lame
- Endodonzia
- Chirurgiche

STANDARD

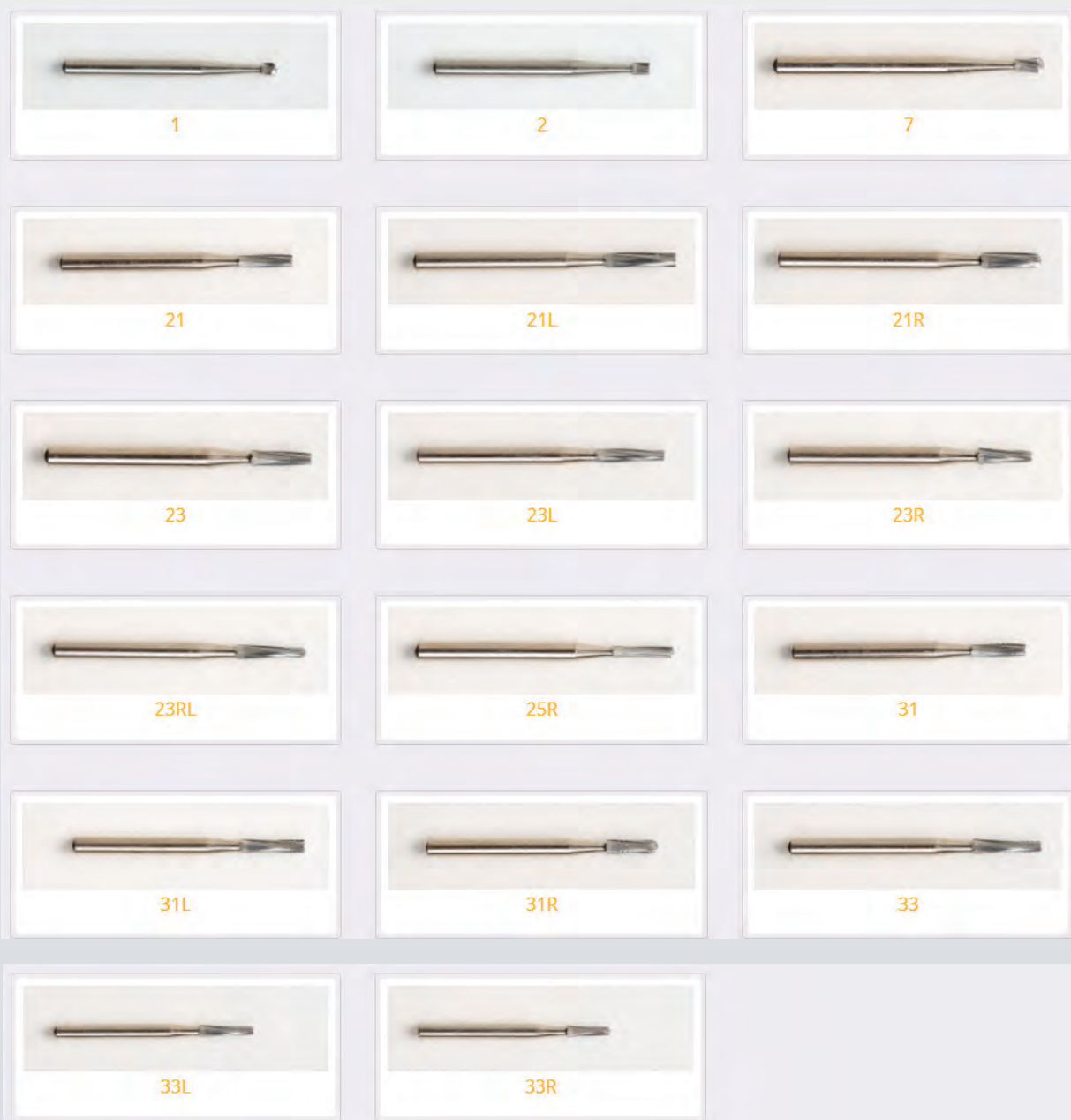

1		L mm										
		0.5	0.6	0.8	1	1.2	1.4	1.6	1.8	2.1	2.3	
	500.314.001.001.	FG 1.	005	006	008	010	012	014	016	018	021	023
	500.313.001.001.	FG S 1.	X	X	X	010	X	014	X	X	X	X
	500.316.001.001.	FG XL 1.	X	X	X	010	X	014	X	018	X	023
	500.204.001.001.	RA 1.	005	006	008	010	012	014	016	018	X	023
	500.104.001.001.	HP 1.	005	006	008	010	012	014	016	018	X	023



FRESE DENTALI



Studio

AXIS
dental
SWISS QUALITY

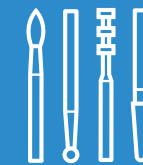

DIAMANTATE CARBURO DI TUNGSTENO CERAMICA LUCIDATRICI

STANDARD

- Escavazione
- Ponti e corone
- Finitura 12 lame
- Finitura 30 lame
- Endodonzia
- Chirurgiche

STANDARD

2



500.314.010.001.

L mm

0.5 0.9 1.1 1.2 1.4 1.6 1.7

FG 2. 006 008 010 012 014 016 018

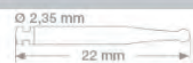

500.204.010.001.

RA 2. X 008 010 012 014 016 018

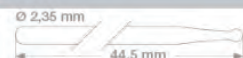

500.104.010.001.

HP 2. X X 010 012 014 X 018

7



500.314.237.001.

L mm

1.6 1.7 1.8

FG 7. 008 010 012



500.204.237.001.

RA 7. X 010 012



FRESE DENTALI



Studio

AXIS
dental
SWISS QUALITY

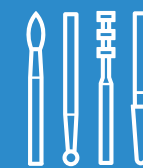

DIAMANTATE CARBURO DI TUNGSTENO CERAMICA LUCIDATRICI

STANDARD

- Escavazione
- Ponti e corone
- Finitura 12 lame
- Finitura 30 lame
- Endodonzia
- Chirurgiche

STANDARD

21



500.314.107.006.

FG 21. 010 012 014 016

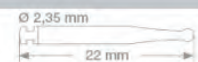

500.204.107.006.

RA 21. 010 X X X



500.104.107.006.

HP 21. 010 012 014 X

L mm	4.2	4.2	4.4	4.4
------	-----	-----	-----	-----

21L



500.314.110.006.

FG 21L. 010 012

L mm 5.8 5.8

--	--	--	--

21R



500.314.137.006.

FG 21R. 009 010 012

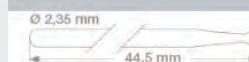

500.104.137.006.

HP 21R. X 010 012

L mm	3.9	4.4	4.4
------	-----	-----	-----

23



500.314.168.006.

FG 23. 010 012 016



500.204.168.006.

RA 23. 010 012 X

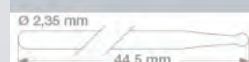

500.104.168.006.

HP 23. 010 X 016

L mm	4.2	4.2	4.6
------	-----	-----	-----



FRESE DENTALI



Studio

AXIS
dental
SWISS QUALITY

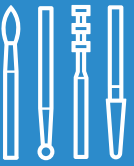

DIAMANTATE CARBURO DI TUNGSTENO CERAMICA LUCIDATRICI

STANDARD

- Escavazione
- Ponti e corone
- Finitura 12 lame
- Finitura 30 lame
- Endodonzia
- Chirurgiche

STANDARD

23L



500.314.171.006

FG 23L 009 012

L mm 6 6



23R



500.314.194.006

FG 23R 010 012 016

L mm 4.2 4.2 4.4



500.204.194.006

RA 23R X 012 016

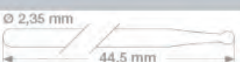

500.104.194.006

HP 23R X 012 016

23RL



500.314.196.006

FG 23RL 010 012

L mm 5.8 5.8



25R



500.314.238.006

FG 25R 010 012

L mm 4.5 4.5





FRESE DENTALI



Studio

AXIS
dental
SWISS QUALITY

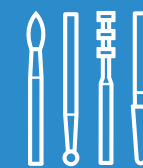

DIAMANTATE CARBURO DI TUNGSTENO CERAMICA LUCIDATRICI

STANDARD

- Escavazione
- Ponti e corone
- Finitura 12 lame
- Finitura 30 lame
- Endodonzia
- Chirurgiche

STANDARD

31

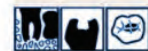

L mm	4.2	4.2	4.2	4.4	4.4
------	-----	-----	-----	-----	-----

500.314.107.007. FG 31. 009 010 012 014 016



500.313.107.007. FG S 31. X X 012 X X



500.316.107.007. FG XL 31. X 010 012 014 X



500.204.107.007. RA 31. 009 010 012 014 X

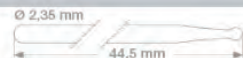

500.104.107.007. HP 31. 009 010 012 014 016

31L

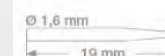

L mm 5.7 5.7

500.314.110.007. FG 31L 010 012

31R



L mm 3.9 4.2 4.2

500.314.137.007. FG 31R. 009 010 012



500.104.137.007. HP 31R. 009 X 012



AXIS
dental
SWISS QUALITY



FRESE DENTALI



Studio

AXIS
dental
SWISS QUALITY

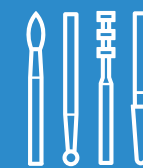

















DIAMANTATE CARBURO DI TUNGSTENO CERAMICA LUCIDATRICI







STANDARD

- Escavazione
- Ponti e corone
- Finitura 12 lame
- Finitura 30 lame
- Endodonzia
- Chirurgiche

STANDARD

33		L mm			
		4.2	4.2	4.4	4.8
					
					
	500.314.168.007.	FG 33.	010	012	016 021
					
	500.316.168.007.	FG XL 33.	X	012	016 X
					
	500.204.168.007.	RA 33.	010	012	X *
					
	500.104.168.007.	HP 33.	010	012	016 021

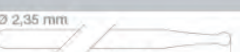
33L		L mm		
		5.5	5.5	5.5
				
				
	500.314.171.007.	FG 33L.	009	010 012
				
	500.104.171.007.	HP 33L.	X	010 012

33R		L mm		
		4.2	4.2	4.4
				
				
	500.314.194.007.	FG 33R.	010	012 016
				
	500.104.194.007.	HP 33R.	X	X 016



FRESE DENTALI



Studio

AXIS
dental
SWISS QUALITY

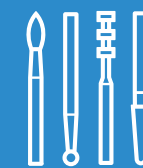

DIAMANTATE CARBURO DI TUNGSTENO CERAMICA LUCIDATRICI

- Standard
- **ESCAVAZIONE**
- Ponti e corone
- Finitura 12 lame
- Finitura 30 lame
- Endodonzia
- Chirurgiche

ESCAVAZIONE

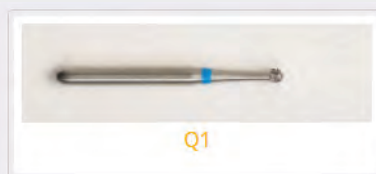

1S

L mm	1	1.2	1.4	1.6	1.8	2.1	2.3	
 500.314.001.003.	FG 1S.	010	012	014	016	018	021	023
 500.204.001.003.	RA 1S.	010	012	014	016	018	021	023
 500.205.001.003.	RA L 1S.	010	012	014	016	018	021	023

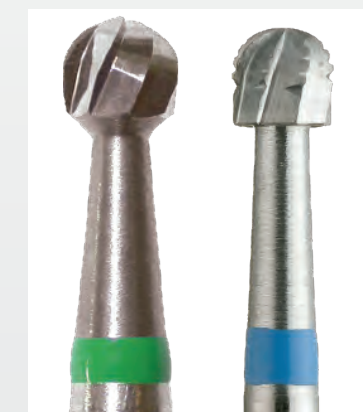

Q1

L mm	1	1.2	1.4	1.6	1.8	2.1	2.3	
 500.314.001.002.	FG Q1.	010	012	014	016	018	021	023
 500.204.001.002.	RA Q1.	010	012	014	016	018	021	023
 500.205.001.002.	RA L Q1.	010	012	014	016	018	021	023



FRESE DENTALI



Studio

AXIS
dental
SWISS QUALITY

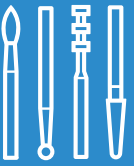

DIAMANTATE CARBURO DI TUNGSTENO CERAMICA LUCIDATRICI



- Standard
- Escavazione
- PONTI E CORONE**
- Finitura 12 lame
- Finitura 30 lame
- Endodonzia
- Chirurgiche

Frese specifiche e fabbricate con un carburo di tungsteno speciale, che permette di affrontare con una grande efficacia il taglio dei metalli delle corone e ponti.

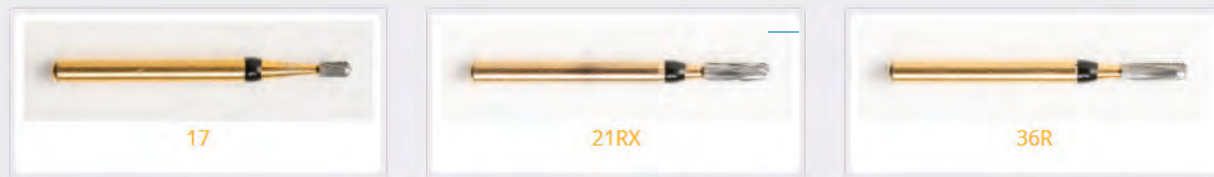
PONTI E CORONE



17





Ø 1,6 mm
19 mm

L mm 2

500.314.107.006. FG 17. 010

21RX





Ø 1,6 mm
19 mm

L mm 4.2 4.2

500.314.137.019. FG 21RX. 010 012

36R

Ø 1,6 mm
19 mm

L mm 4.2

500.314.137.008. FG 36R. 012



36R



FRESE DENTALI



Studio

AXIS
dental
SWISS QUALITY

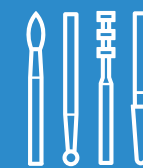



DIAMANTATE CARBURO DI TUNGSTENO CERAMICA LUCIDATRICI

- Standard
- Escavazione
- Ponti e corone
- FINITURA 12 LAME**
- Finitura 30 lame
- Endodonzia
- Chirurgiche

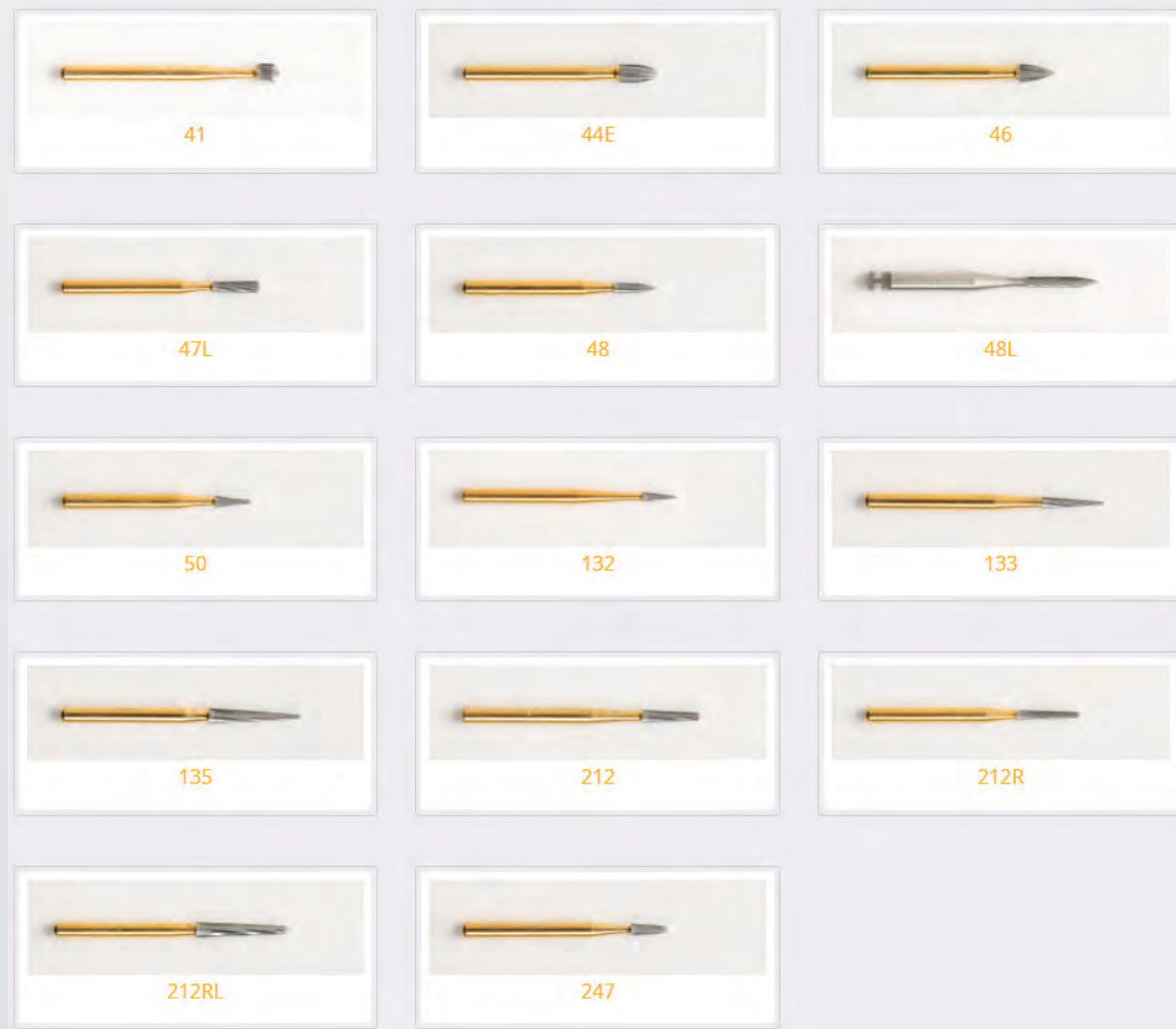
FINITURA 12 LAME



41

500.314.001.072



L mm	1.4	1.8	2.3
FG 41.	014	018	023

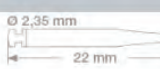

500.204.277.072

RA 41.	014	018	023
--------	-----	-----	-----

44E

500.314.277.072

L mm	3.1	3.5	4.2
FG 44E.	014	018	023



500.204.277.072

RA 44E.	X	018	023
---------	---	-----	-----



FRESE DENTALI



Studio

AXIS
dental
SWISS QUALITY

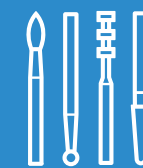





DIAMANTATE CARBURO DI TUNGSTENO CERAMICA LUCIDATRICI

- Standard
- Escavazione
- Ponti e corone
- FINITURA 12 LAME**
- Finitura 30 lame
- Endodonzia
- Chirurgiche

FINITURA 12 LAME

46

L mm 3.5 3.5 3.8 4







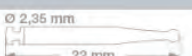

500.314.254.072. FG 46. 014 X 018 023

500.204.254.072. RA 46. X 016 X X

47L

L mm 4.4 4.4







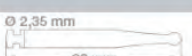

500.314.234.072. FG 47L. 012 014

500.204.234.072. RA 47L. 012 X

48

L mm 3.6 3.6 3.6



500.314.246.071. FG 48. 009 010 012

48L







L mm 8



500.204.249.072.012. RA 48L. 012

50

L mm 3.2



500.314.465.041.012. FG 50. 012



FRESE DENTALI



Studio

AXIS
dental
SWISS QUALITY

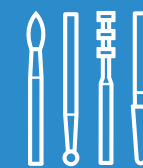

DIAMANTATE CARBURO DI TUNGSTENO CERAMICA LUCIDATRICI

- Standard
- Escavazione
- Ponti e corone
- FINITURA 12 LAME**
- Finitura 30 lame
- Endodonzia
- Chirurgiche

FINITURA 12 LAME

132



Ø 1,6 mm
19 mm

500.314.181.072.

L mm 3

FG 132. 009

133



Ø 1,6 mm
19 mm

500.314.217.072.

L mm 5,5

FG 133. 010

135



Ø 1,6 mm
19 mm

500.314.217.072.

L mm 8

FG 135. 014



212RL

212



Ø 1,6 mm
19 mm

500.314.197.072.012

L mm 5,5

FG 212. 012

212R



Ø 1,6 mm
19 mm

500.314.197.072.010

L mm 6

FG 212R. 010

212RL



Ø 1,6 mm
19 mm

500.314.198.072.016

L mm 9

FG 212RL. 016



FRESE DENTALI



Studio

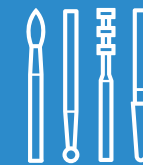

DIAMANTATE CARBURO DI TUNGSTENO CERAMICA LUCIDATRICI

- Standard
- Escavazione
- Ponti e corone
- FINITURA 12 LAME**
- Finitura 30 lame
- Endodonzia
- Chirurgiche

FINITURA 12 LAME

247

500.314.499.072

L mm	2.7	2.8	2.9
FG 247.	009	010	012



Nel nostro sito WEB troverai tutti i nostri riferimenti di frese con informazioni dettagliate per poter scegliere i prodotti adeguati alle necessità del professionista.

VISITA TRAMITE IL QR.

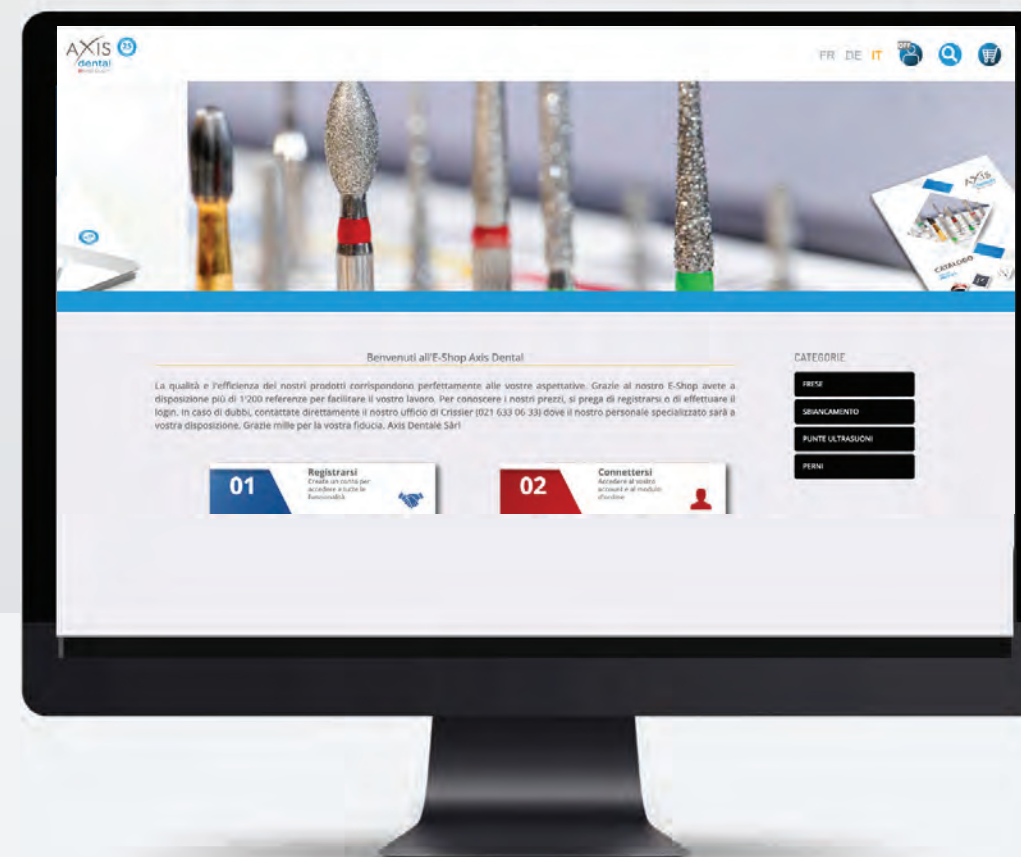

VISITA IL NOSTRO SITO

WEB



FRESE DENTALI



Studio

AXIS
dental
SWISS QUALITY

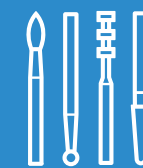

DIAMANTATE CARBURO DI TUNGSTENO CERAMICA LUCIDATRICI

- Standard
- Escavazione
- Ponti e corone
- Finitura 12 lame
- FINITURA 30 LAME**
- Endodonzia
- Chirurgiche

FINITURA 30 LAME



U41

Ø 1,6 mm
19 mm

L mm 1.8 2.3

500.314.001.101. FG U41. 018 023

U44E

Ø 1,6 mm
19 mm

L mm 3.5

500.314.277.101.018 FG U44E. 018

U48

Ø 1,6 mm
19 mm

L mm 5.5

500.314.247.101.012 FG U48. 012

U50

Ø 1,6 mm
19 mm

L mm 3.2

500.314.465.101.012 FG U50. 012



FRESE DENTALI



Studio

AXIS
dental
SWISS QUALITY

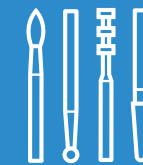

DIAMANTATE CARBURO DI TUNGSTENO CERAMICA LUCIDATRICI

- Standard
- Escavazione
- Ponti e corone
- Finitura 12 lame
- FINITURA 30 LAME**
- Endodonzia
- Chirurgiche

FINITURA 30 LAME

U212



Ø 1,6 mm
19 mm

500.314.197.102.010

L mm 6

FG U212. 010

U247



Ø 1,6 mm
19 mm

500.314.499.101.012

L mm 3.4

FG U247. 012

IL FORMATO PIÙ AGILE PER AVERE TUTTO A PORTATA DI MANO.

Le nostre soluzioni includono una vasta gamma di riferimenti dentali sia per il lavoro in clinica sia in laboratorio.

Tutte incorporano i migliori materiali garantendo efficacia, precisione, rapidità di taglio, geometrie perfette e assenza di vibrazioni.

Possiamo creare un kit personalizzato per voi.



**KIT DI FRESE
PERSONALIZZATI**

AXIS
dental
SWISS QUALITY



FRESE DENTALI



Studio

AXIS
dental
SWISS QUALITY

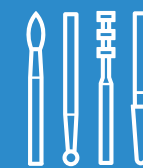

DIAMANTATE CARBURO DI TUNGSTENO CERAMICA LUCIDATRICI

- Standard
- Escavazione
- Ponti e corone
- Finitura 12 lame
- Finitura 30 lame
- ENDODONZIA**
- Chirurgiche

ENDODONZIA

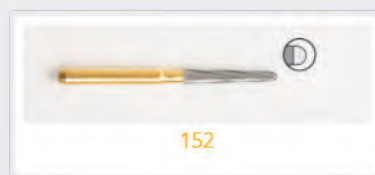
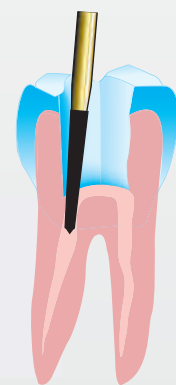

152

500.315.210.295.014 FG L 152. 014 L mm 9

500.316.210.295.014 FG XL 152. 014

560

500.316.196.336.008 FG XL 560. 008 L mm 4



FRESE DENTALI



Studio

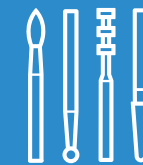

DIAMANTATE CARBURO DI TUNGSTENO CERAMICA LUCIDATRICI

- Standard
- Escavazione
- Ponti e corone
- Finitura 12 lame
- Finitura 30 lame
- Endodonzia
- CHIRURGICHE

CHIRURGICHE



SIAMO VICINI A VOI

La nostra vasta rete commerciale nazionale e internazionale è sempre attenta alle necessità delle loro cliniche e laboratori di zona.

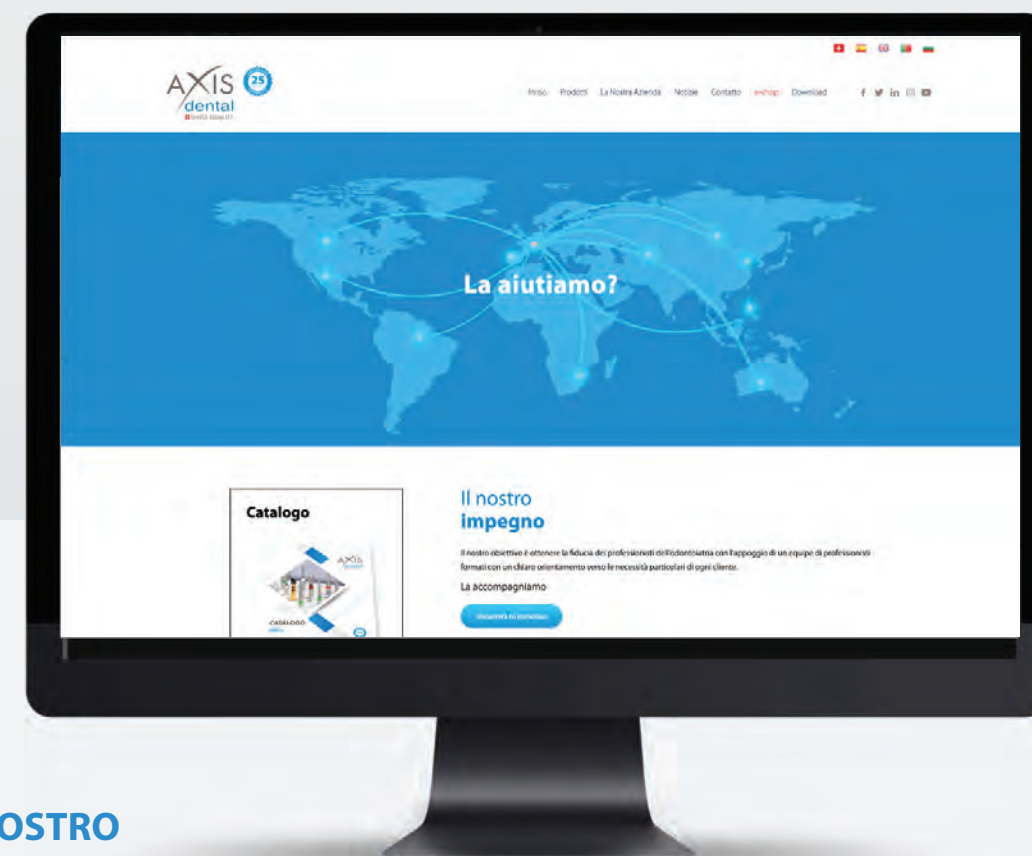

CONSULTATE IL NOSTRO

TECNICO COMMERCIALE





FRESE DENTALI



Studio

AXIS
dental
SWISS QUALITY

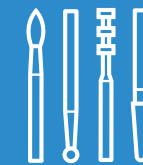



DIAMANTATE CARBURO DI TUNGSTENO CERAMICA LUCIDATRICI

- Standard
- Escavazione
- Ponti e corone
- Finitura 12 lame
- Finitura 30 lame
- Endodonzia
- CHIRURGICHE**

CHIRURGICHE

141

L mm	1	1.4	1.8	2.3	2.7	3.1	3.5	4	5
------	---	-----	-----	-----	-----	-----	-----	---	---



500.205.001.251.	RA L 141.	010	014	018	023	027	031	035	040	050
------------------	-----------	-----	-----	-----	-----	-----	-----	-----	-----	-----



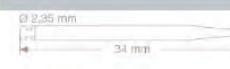

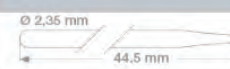
500.206.001.251.	RA XL 141.	010	014	018	023	027	031	035	040	050
------------------	------------	-----	-----	-----	-----	-----	-----	-----	-----	-----



500.104.001.251.	HP 141.	010	014	018	023	027	031	035	040	050
------------------	---------	-----	-----	-----	-----	-----	-----	-----	-----	-----

151

L mm	11
------	----



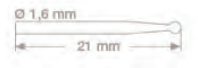

500.315.199.295.014	FG L 151.	014
---------------------	-----------	-----

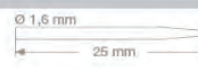

500.316.199.295.014	FG XL 151.	014
---------------------	------------	-----

CHIRURGICHE

161



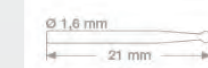

L mm	10	10
------	----	----



500.315.408.295.	FG L 161.	012	014
------------------	-----------	-----	-----

162A

L mm	10
------	----



500.316.408.298.016	FG XL 162A.	016
---------------------	-------------	-----

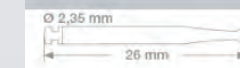

500.205.408.298.016	RA L 162A.	016
---------------------	------------	-----



500.104.408.298.016	HP 162A.	016
---------------------	----------	-----



FRESE DENTALI



Studio

AXIS
dental
SWISS QUALITY

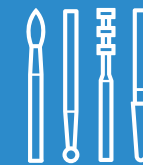

DIAMANTATE CARBURO DI TUNGSTENO CERAMICA LUCIDATRICI

- Standard
- Escavazione
- Ponti e corone
- Finitura 12 lame
- Finitura 30 lame
- Endodonzia
- CHIRURGICHE**

CHIRURGICHE

162



L mm 10

500.316.408.297.018 FG XL 162. 018



500.205.408.297.018 RA L 162. 018

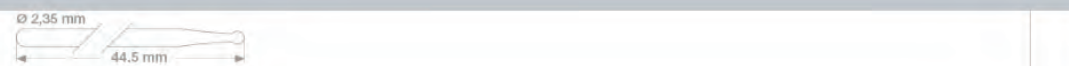

500.104.408.297.018 HP 162. 018

166



L mm 11

500.205.409.297.021 RA L 166. 021



500.104.409.297. HP 166. 021

CHIRURGICHE

167



L mm 11

500.205.410.297. RA L 167. 023

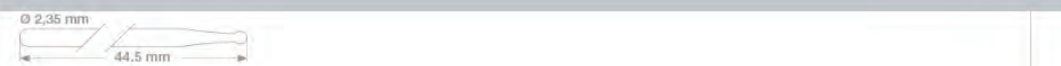

500.104.410.297. HP 167. 023

389



L mm 10

.316.494.020.014 FG XL 389. 014



FRESE DENTALI



Studio

AXIS
dental
SWISS QUALITY

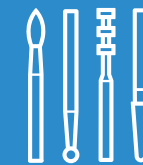

DIAMANTATE CARBURO DI TUNGSTENO CERAMICA LUCIDATRICI

La soluzione ideale per tagliare i tessuti morbidi mentre si cauterizza la ferita. Un'alternativa semplice ed efficace al bisturi elettrico.



Applicazione

- Svuotare cavità profonde.
- Lacerazione di tessuto granulare interradicolare.
- Papillectomia / ritirare iperplasia gengivale.
- Esposizione di sezioni di impianti osteointegrati e denti inclusi.

Prima di usare la CSTT, si deve lavare di pus e sangue la zona e questa deve essere asciugata mediante cotone o l'aspiratore salivare. La punta della CSTT si deve muovere attraverso il tessuto con piccoli movimenti di pennellate in un angolo di 30-45 gradi, evitando di forzare la punta dell'escavatore nel tessuto o tagliare troppo profondo in un solo taglio.

La CSTT si muove nel canale mediante un equilibrato movimento da percorrere fino alla profondità necessaria. Per evitare qualsiasi perdita di tessuto è importante preservare l'epitelio della gengiva marginale.

Usando la CSTT correttamente, in tutte le sue applicazioni, vedrà che la CSTT non è solo capace di sostituire i bisturi elettrici e quelli convenzionali, ma di evitarci anche l'uso del filo retrattore in molte occasioni.

ESEMPI

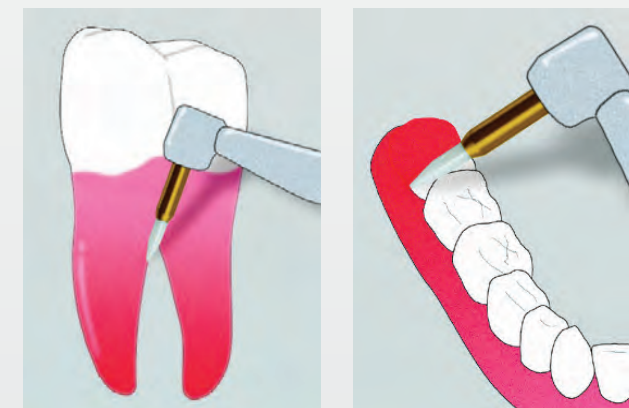

*Ritagliando
tessuti morbidi*



FRESE DENTALI



Studio

AXIS
dental
SWISS QUALITY

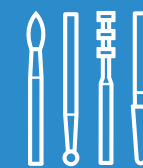

DIAMANTATE CARBURO DI TUNGSTENO CERAMICA LUCIDATRICI

CERAMICA



CSTT



CSTT L

CSTT

L mm	5
Ø mm	1.5

700.314.287.484. FG CSTT.

CSTTL

L mm	8.5
Ø mm	1.5

FG CSTTL.

Informazioni per l'utente

La CSTT si utilizza con alta rotazione in turbina (300.000 – 450.000 rpm). Usata correttamente l'energia cinetica produce coagulazione per calore senza bruciare il tessuto. Quando usiamo la CSTT, bisogna evitare il contatto eccessivo con i denti o il tessuto osseo.

Raffreddamento

Si utilizza senza acqua e senza spray di raffreddamento.

Pulizia

Acqua e detergente. Avvertenza: non utilizzare nessun dissolvente per pulirlo.

Sterilizzazione

Con calore secco a 180°C di temperatura massima o con autoclave di vapore a 134°C per 18 minuti

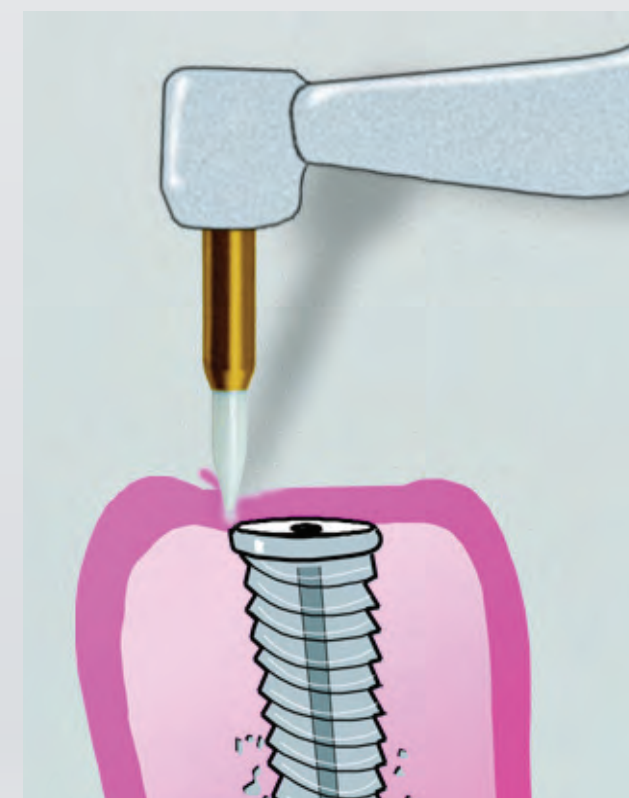



FRESE DENTALI



Studio

AXIS
dental
SWISS QUALITY

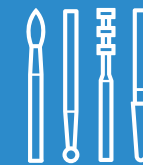

DIAMANTATE CARBURO DI TUNGSTENO CERAMICA **LUCIDATRICI**

Diverse soluzioni di pulitori con aditivi adattati a qualsiasi tipo di materiale che si trova nell'ambito dentale.



NUOVA GENERAZIONE DI LUCIDATORI

Una lucidazione eccezionale aggiunge un valore extra ai restauri realizzati. L'aspetto brillante che sarà raggiunto dalla nuova generazione di lucidatori di Axis Dental manterrà a lungo termine la bellezza e perfezione del lavoro realizzato.

Questa nuova generazione di lucidatori ci fa sentire orgogliosi di tutto lo sforzo realizzato dalla compagnia nella ricerca, sviluppo e innovazione. Ottenere prodotti di alta qualità introducendo materiali innovativi è per noi sinonimo di successo. Un successo ricompensato dalla soddisfazione dei nostri clienti.

Il professionista affronta una moltitudine di problemi quando realizza i trattamenti, alcuni di essi inaspettati, come possono essere l'allergia a determinati materiali.

Queste responsabilità del personale sanitario sono molto importanti per Axis Dental e comportano una parte del nostro impegno con l'Odontoiatra. Sostituire il silicone dei lucidatori tradizionali con il poliuretano riesce a risolvere numerosi problemi di allergia che interessano una parte dei pazienti.

APPLICAZIONE DEL PRODOTTO

Il lucidatore si utilizza con spray d'acqua e senza esercitare pressione in modo tale che l'odontoiatra dovrà cercare solo il contatto con la materia.



RIVOLUZIONI E PROTOCOLLO DI UTILIZZO

Consigliamo di rispettare le rivoluzioni per l'uso dei lucidatori, così assicuriamo un'efficacia massima, facendo in modo che il professionista possa lavorare più velocemente, il lucidatore si usuri meno, allunghi la sua vita utile e pertanto, si produca un risparmio di materiale per la clinica.

Un eccesso di rivoluzioni smuserà il lucidatore, il calore salirà in modo immediato annullando l'efficacia del lucidatore e, peraltro, non si raggiungerà il risultato estetico adeguato.

I professionisti di Axis Dental integrano un'equipe formata per poter risolvere tutti i tuoi dubbi sulle rivoluzioni adeguate o qualsiasi domanda che si riferisca al corretto uso del materiale. Contatta il responsabile della tua zona che sarà grato di poter aiutarti.

Lucidatori dentali di nuova generazione

AXIS
dental
SWISS QUALITY



FRESE DENTALI



Studio

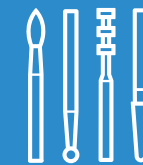

DIAMANTATE CARBURO DI TUNGSTENO CERAMICA **LUCIDATRICI**

TIPOLOGIA E ABRASIONE

Lucidatori universali per amalgama, oro, leghe di metalli non preziosi, titanio.

Con poliuretano e carburo di silicio

- Serie 10.. Levigare Abrasione 60 / 105 micre
- Serie 20.. Prelucidatura Abrasione 20 / 25 micre
- Serie 30.. Effetto specchio Abrasione 2 / 4 micre

Lucidatori per compositi

Con poliuretano e carburo di silicio

- Serie 40.. Prelucidatura Abrasione 45 / 75 micre
- Serie 50.. Effetto specchio Abrasione 2 / 4 micre

Lucidatori per compositi e ceramica ibrida

Con poliuretano e diamante

- Serie X45.. Prelucidatura Abrasione 50 / 60 micre
- Serie X55.. Brillantezza specchio Abrasione 4 / 8 micre

Lucidatori per porcellana (ceramica), dissilicato di litio, ossido di ceramico, porcellana

Con poliuretano e diamante

- Serie X70.. Prelucidatura Abrasione 40 / 58 micre
- Serie X80.. Effetto specchio Abrasione 10 / 20 micre

Pennelli

- Proflassi
- Nylon
- Diamante

Pietre

- Verde
- Arkansas

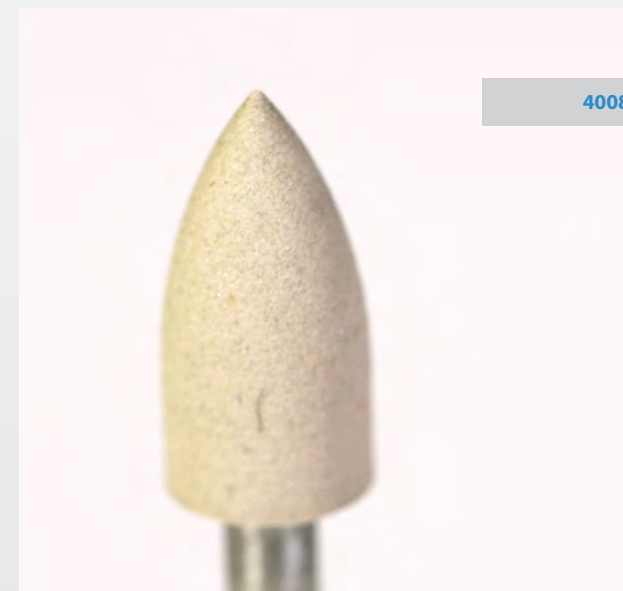
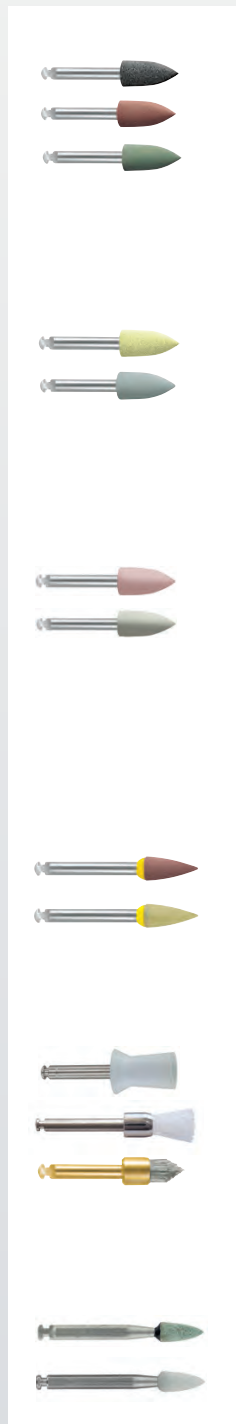



FRESE DENTALI



Studio

AXIS
dental
SWISS QUALITY

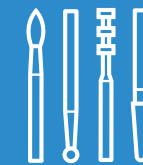

DIAMANTATE CARBURO DI TUNGSTENO CERAMICA **LUCIDATRICI**

- SPAZZOLE
- Universale
- Composito
- Ceramica
- Pietra

SPAZZOLE / Proflassi

BPH



Ø mm 6



RA BPH.

SPAZZOLE / Proflassi nylon

BPNC



Ø mm 6



RA BPNC.

SPAZZOLE / Proflassi nylon

BPNN



Ø mm 4



RA BPNN.

BPNP



Ø mm 4



RA BPNP.



FRESE DENTALI



Studio

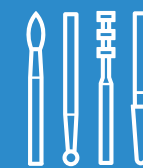

DIAMANTATE CARBURO DI TUNGSTENO CERAMICA **LUCIDATRICI**

- SPAZZOLE
- Universale
- Composito
- Ceramica
- Pietra

SPAZZOLE / Diamentato

BP D C

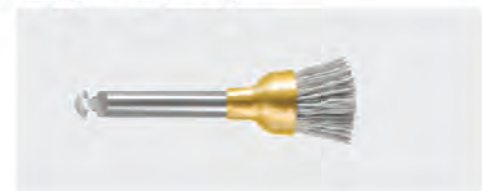

Ø mm 6



RA BP D C.

BP D N

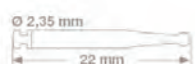

Ø mm 4



RA BP D N.

BP D P



Ø mm 4



RA BP D P.

SCELTA DELLE FORME

Come scegliere la forma adeguata?

Al momento di scegliere la forma di un lucidatore non si deve prendere in considerazione solo il tipo di trattamento da realizzare, ma è importante prendere in considerazione anche il risparmio che possiamo fare nella spesa del materiale.

All'interno della stessa famiglia, la durata della vita del prodotto può essere abbastanza superiore. Ad esempio, la forma 4014 (forma a disco) ha una vita utile 2 volte superiore rispetto a una forma 4006 (forma a punta).

Questa situazione migliora ancora di più quando facciamo un paragone tra la forma 4012 (forma a ruota) che ha una vita utile 2,5 volte superiore rispetto alla 4006 (forma a punta).

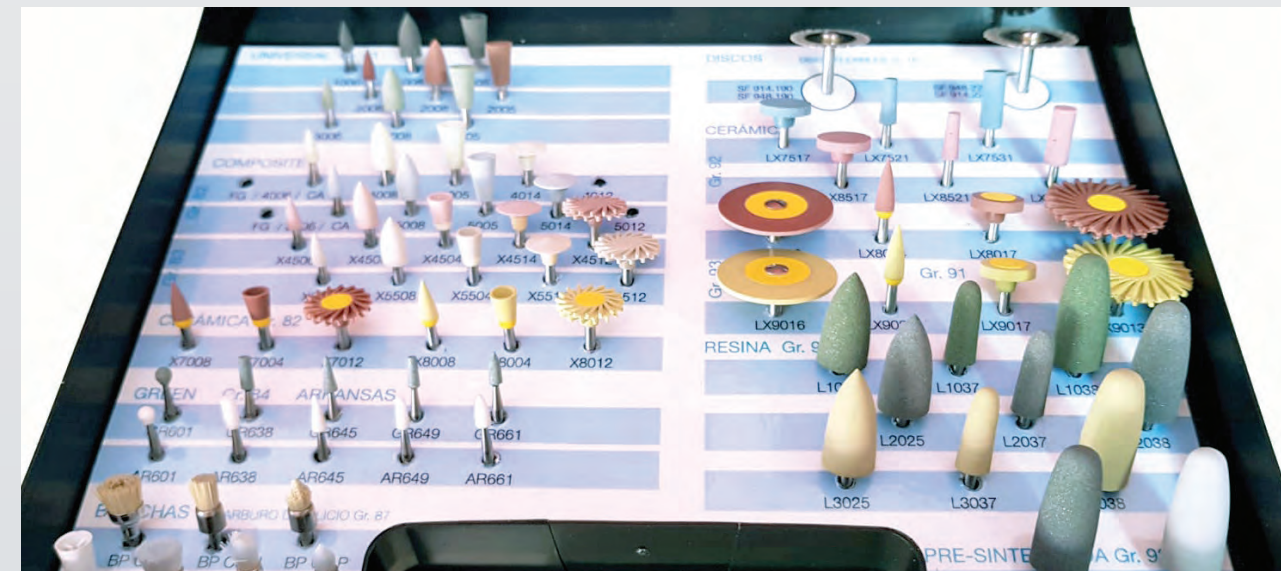



FRESE DENTALI



Studio

AXIS
dental
SWISS QUALITY

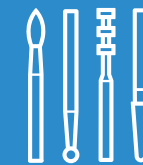

DIAMANTATE CARBURO DI TUNGSTENO CERAMICA **LUCIDATRICI**

- Spazzole
- UNIVERSALE**
- Composito
- Ceramica
- Pietra

UNIVERSALE / Sgrossatura

1005



653.204.030.533.

L mm 9.5
Ø mm 6.5

RA 1005.

1006

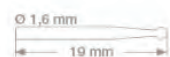

653.314.243.533.

L mm 7.5
Ø mm 3

FG 1006.



653.204.243.533.

RA 1006.

1008

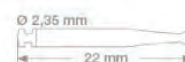

653.204.300.533.

L mm 10
Ø mm 5

RA 1008.

1012



653.204.300.533.

L mm 1.5
Ø mm 14

RA 1012.



FRESE DENTALI



Studio

AXIS
dental
SWISS QUALITY

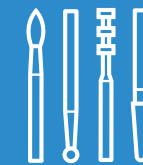

DIAMANTATE CARBURO DI TUNGSTENO CERAMICA **LUCIDATRICI**

- Spazzole
- UNIVERSALE**
- Composito
- Ceramica
- Pietra

UNIVERSALE / Lucidatura preliminare

2005



L mm 9.5
Ø mm 6.5



653.204.030.513

RA 2005

2006



L mm 7.5
Ø mm 3



653.314.243.513

FG 2006

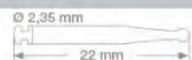

653.204.297.513

RA 2006

2008



L mm 10
Ø mm 5



653.204.300.513

RA 2008

2012



L mm 1.5
Ø mm 14



653.204.297.513

RA 2012



FRESE DENTALI



Studio

AXIS
dental
SWISS QUALITY

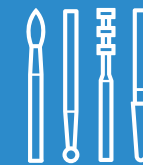

DIAMANTATE CARBURO DI TUNGSTENO CERAMICA **LUCIDATRICI**

- Spazzole
- UNIVERSALE**
- Composito
- Ceramica
- Pietra

UNIVERSALE / Luciadatura a specchio

3005



653.204.030.503.

L mm 9.5
Ø mm 6.5

RA 3005.

3006



653.314.243.503.

L mm 7.5
Ø mm 3

FG 3006.

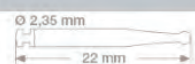

653.204.297.503.

RA 3006.

3008



653.204.300.503.

L mm 10
Ø mm 5

RA 3008.

3012



653.204.301.503.

L mm 1.5
Ø mm 14

RA 3012.



FRESE DENTALI



Studio

AXIS
dental
SWISS QUALITY

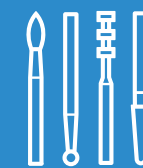

DIAMANTATE CARBURO DI TUNGSTENO CERAMICA **LUCIDATRICI**

- Spazzole Universale
- COMPOSITO**
- Ceramica
- Pietra

COMPOSITO / Lucidatura preliminare

4005



L mm 9.5
 Ø mm 6.5



653.204.030.524.

RA 4005.

4006



L mm 7.5
 Ø mm 3



653.314.243.524.

FG 4006.

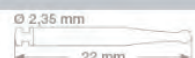

653.204.297.524.

RA 4006.

4008



L mm 10
 Ø mm 5



653.204.300.524.

RA 4008.

4012



L mm 1.5
 Ø mm 14



653.204.543.524.

RA 4012.

4014



L mm 2.5
 Ø mm 10



653.204.307.524.

RA 4014.



FRESE DENTALI



Studio

AXIS
dental
SWISS QUALITY

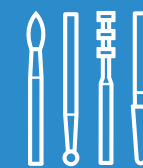

DIAMANTATE CARBURO DI TUNGSTENO CERAMICA **LUCIDATRICI**

- Spazzole Universale
- COMPOSITO**
- Ceramica
- Pietra

COMPOSITO / lucidatura a specchio

5005



L mm 9.5
Ø mm 6.5



653.204.030.514.

RA 5005.

5006



L mm 7.5
Ø mm 3



653.314.243.514.

FG 5006.

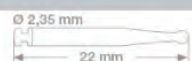

653.204.297.514.

RA 5006.

5008



L mm 10
Ø mm 5



653.204.300.514.

RA 5008.

5012



L mm 1.5
Ø mm 14



653.204.543.514.

RA 5012.

5014



L mm 2.5
Ø mm 10



653.204.304.514.

RA 5014.



FRESE DENTALI



Studio

AXIS
dental
SWISS QUALITY

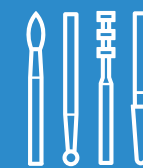

DIAMANTATE CARBURO DI TUNGSTENO CERAMICA **LUCIDATRICI**

- Spazzole
- Universale
- COMPOSITO**
- Ceramica
- Pietra

COMPOSITO / Lucidatura preliminare / Diamanti



X4504



L mm 7.5
Ø mm 6



803.204.030.523

RA X4504.

X4506



L mm 7.5
Ø mm 3



803.314.243.523

FG X4506.

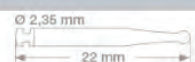

803.204.297.523

RA X4506.

X4508



L mm 10
Ø mm 5



803.204.300.523

RA X4508.

X4512



L mm 1.5
Ø mm 14



803.204.543.523

RA X4512.

X4514



L mm 2.5
Ø mm 10



803.204.304.523

RA X4514.

AXIS
dental
SWISS QUALITY



FRESE DENTALI



Studio

AXIS
dental
SWISS QUALITY

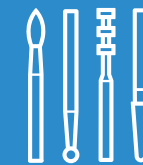

DIAMANTATE CARBURO DI TUNGSTENO CERAMICA **LUCIDATRICI**

- Spazzole
- Universale
- COMPOSITO**
- Ceramica
- Pietra

COMPOSITO / Lucidatura a specchio / Diamanti



X5504



L mm 7.5
Ø mm 6



803.204.030.503

RA X5504.

X5506



L mm 7.5
Ø mm 3



803.314.243.503

FG X5506.

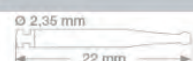

803.204.297.503

RA X5506.

X5508



L mm 10
Ø mm 5



803.204.300.503

RA X5508.

X5512



L mm 1.5
Ø mm 14



803.204.543.503

RA X5512.

X5514



L mm 2.5
Ø mm 10



803.204.304.503

RA X5514.

AXIS
dental
SWISS QUALITY



FRESE DENTALI



Studio

AXIS
dental
SWISS QUALITY

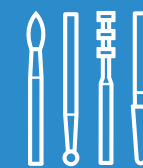

DIAMANTATE CARBURO DI TUNGSTENO CERAMICA **LUCIDATRICI**

- Spazzole
- Universale
- Composito
- CERAMICA**
- Pietra

Ceramica / Lucidatura preliminare /Diamanti



X7004



L mm 7,5
Ø mm 6



803.204.030.524

RA X7004.

X7008



L mm 10
Ø mm 4



803.204.243.524

RA X7008.

X7012



L mm 1,5
Ø mm 14



803.204.543.524

RA X7012.

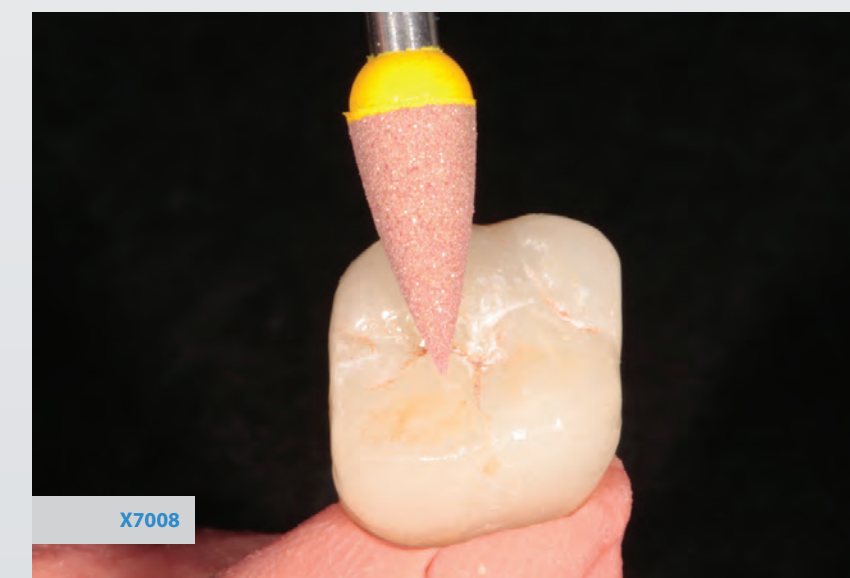

X7008

AXIS
dental
SWISS QUALITY



FRESE DENTALI



Studio

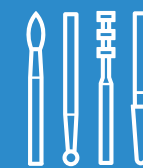

DIAMANTATE CARBURO DI TUNGSTENO CERAMICA **LUCIDATRICI**

- Spazzole
- Universale
- Composito
- CERAMICA**
- Pietra

Ceramica / Lucidatura a specchio / Diamanti



X8004



803.204.030.513

L mm 7.5
Ø mm 6

RA X8004

X8008

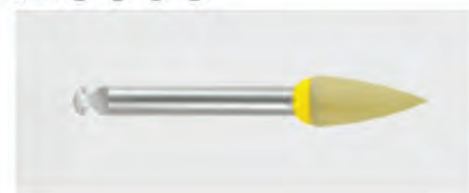

803.204.243.513

L mm 10
Ø mm 4

RA X8008

X8012



803.204.543.513

L mm 1.5
Ø mm 14

RA X8012



FRESE DENTALI



Studio

AXIS
dental
SWISS QUALITY

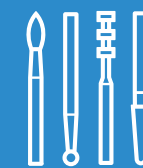

DIAMANTATE CARBURO DI TUNGSTENO CERAMICA **LUCIDATRICI**

- Spazzole
- Universale
- Composito
- Ceramica
- PIETRA**

PIETRA GREEN / Fine

GR601



L mm 3



655.314.001.513.

FG GR601. 030

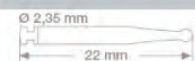

655.204.001.513.

RA GR601. 030

GR638



L mm 7



655.314.110.513.

FG GR638. 030



655.204.110.513.

RA GR638. 030

PIETRA GREEN / Fine

GR645



L mm 7



655.314.161.513.

FG GR645. 030



655.204.161.513.

RA GR645. 030

GR649



L mm 7



655.314.171.513.

FG GR649. 027

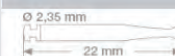

655.204.171.513.

RA GR649. 027

GR661



L mm 6.5



655.314.288.513.

FG GR661. 030

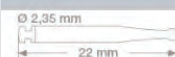

655.204.288.513.

RA GR661. 030

AXIS
dental
SWISS QUALITY



FRESE DENTALI



Studio

AXIS
dental
SWISS QUALITY

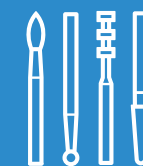

DIAMANTATE CARBURO DI TUNGSTENO CERAMICA **LUCIDATRICI**

- Spazzole
- Universale
- Composito
- Ceramica
- PIETRA**

PIETRA ARKANSAS / Extra fine

AR601



L mm 3



635.314.001.505.

FG AR601. 030



635.204.001.505.

RA AR601. 030

AR638



L mm 7

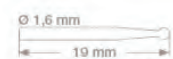

635.314.110.505.

FG AR638. 030



635.204.110.505.

RA AR638. 030

PIETRA ARKANSAS / Extra fine

AR645



L mm 7



635.314.161.505.

FG AR645. 030

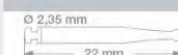

635.204.161.505.

RA AR645. 030

AR649

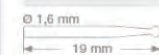

635.314.171.505.

FG AR649. 027



635.204.171.505.

RA AR649. 027

AR661



L mm 6,5



635.314.288.505.

FG AR661. 030



635.204.288.505.

RA AR661. 030

AXIS
dental
SWISS QUALITY



FRESE DENTALI



Laboratorio

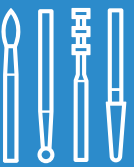

La nostra selezione di frese per laboratorio offre una gamma di varietà di frese di diamante, di carburo di tungsteno e lucidatori che soddisfano le necessità del professionista tecnico dentale.



Come ordinare

863

	HP 863.	012	016	
				1
			X	2
		X		3

1 Con il riferimento Axis
 Aggiungendo il diametro al riferimento Axis indicato.
HP 863.016

2 Tramite il nostro e-shop
 Selezionando direttamente il diametro della punta desiderata nell'e-shop. Il sistema suggerirà automaticamente il riferimento Axis.
HP F 863.012

3 Con il numero ISO
 Aggiungendo il diametro al numero ISO indicato.
806.313.001.524.010



FRESE DENTALI



Laboratorio

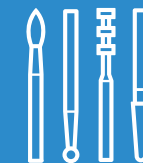

DIAMANTATE CARBURO DI TUNGSTENO LUCIDATRICI VARI

- STANDARD
- Dischi Super Flex
- Diamanti DLC

STANDARD





STANDARD

801



L mm	1.2	1.6	2.3	2.9	3.5	4.2
------	-----	-----	-----	-----	-----	-----





	806.104.001.524.	HP 801.	012	016	023	029	035	042
	806.104.001.534.	HP G 801.	X	X	023	029	X	X

825



L mm	0.8	1.1
------	-----	-----





	806.104.304.524.	HP 825.	018	040
---	------------------	---------	-----	-----

835



L mm	4	4	6
------	---	---	---



	806.104.107.524.	HP 835.	012	021	025
---	------------------	---------	-----	-----	-----



FRESE DENTALI



Laboratorio

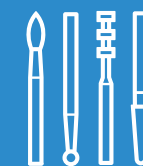

DIAMANTATE CARBURO DI TUNGSTENO LUCIDATRICI VARI

STANDARD
Dischi Super Flex
Diamanti DLC

STANDARD

837



L mm 7



806.104.111.524

HP 837. 016

840



L mm 9 7



806.104.111.524

HP 840. 040 050

STANDARD

848



L mm 10 9



806.104.173.524

HP 848. 018 040

806.104.173.534

HP G 848. 018 X

850



L mm 10 10 9



806.104.199.524

HP 850. 014 025 042

859



L mm 10

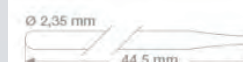

806.104.166.524

HP 859. 018

806.104.166.514

HP F 859. 018





FRESE DENTALI



Laboratorio

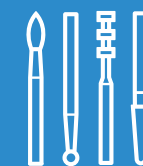

DIAMANTATE CARBURO DI TUNGSTENO LUCIDATRICI VARI

STANDARD
Dischi Super Flex
Diamanti DLC

STANDARD

860



L mm 5 5

806.104.247.524.

HP 860. 012 014

806.104.247.514.

HP F 860. X 014

862

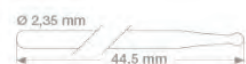

L mm 8

806.104.249.524.

HP 862. 018

863



L mm 10 10

806.104.250.524.

HP 863. 012 016

806.104.250.514.

HP F 863. 012 X

806.104.250.534.

HP G 863. X 016

881



L mm 7 7

806.104.141.524.

HP 881. 016 025



FRESE DENTALI



Laboratorio

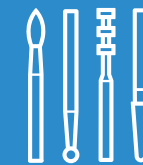

DIAMANTATE CARBURO DI TUNGSTENO LUCIDATRICI VARI

- Standard
- DISCHI SUPER FLEX**
- Diamanti DLC

DISCHI SUPER FLEX

932

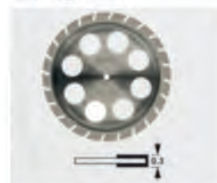

Ø 2,35 mm
44.5 mm

806.104...

HP 932. 450

SF914

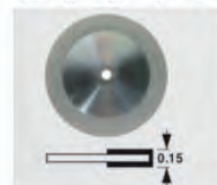

Ø 2,35 mm
22 mm

RA SF914. 190 220

L mm 0.15 0.15

Ø mm 19 22

Ø 2,35 mm
44.5 mm

HP SF914. 190 220

HP SF914. 190 220

SF948

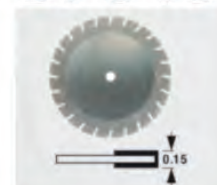

Ø 2,35 mm
22 mm

RA SF948. 190 220

L mm 0.15 0.15

Ø mm 19 22

Ø 2,35 mm
44.5 mm

HP SF948. 190 220

HP SF948. 190 220



FRESE DENTALI



Laboratorio

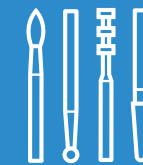

DIAMANTATE

CARBURO DI TUNGSTENO

LUCIDATRICI

VARI

- Standard
- Dischi Super Flex
- DIAMANTI DLC

DIAMANTI DLC

DLC801



L mm 1.6

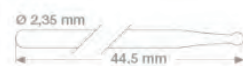

806.104.001..

HP DLC801. 016

DLC850



L mm 10



806.104.199..

HP DLC850. 014

DLC859



L mm 10



806.104.166..

HP DLC859. 018

DLC863



L mm 10



806.104.250..

HP DLC863. 016



FRESE DENTALI



Laboratorio

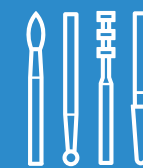

DIAMANTATI CARBURO DI TUNGSTENO LUCIDATRICI VARI

Le frese di carburo di tungsteno sono il miglior strumento per il lavoro su materie morbide e dure, secondo le necessità del professionista e riducono il tempo di intervento.

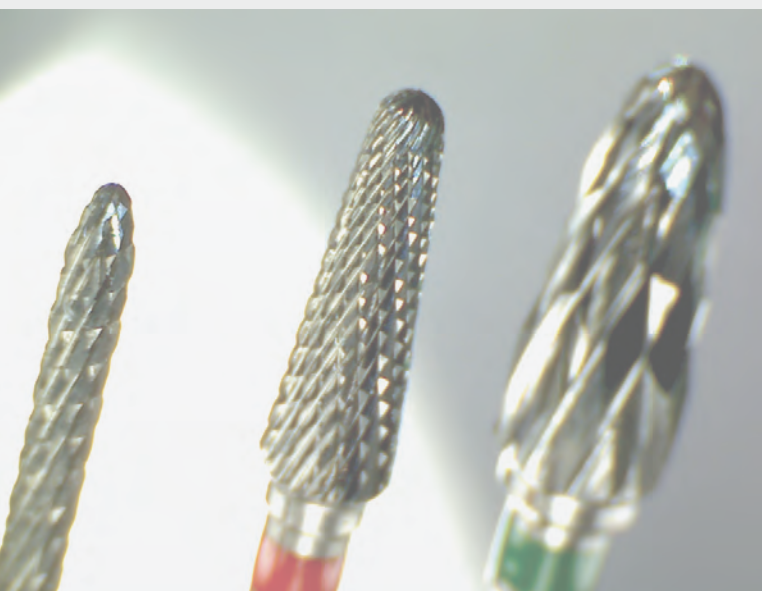

Applicazione Gesso



CX SG

Applicazioni Gesso e Resina

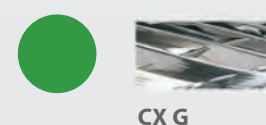

CX G

Applicazioni Leghe e Metalli Preziosi

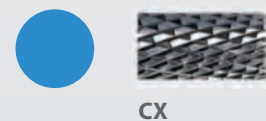

CX

Applicazioni Leghe e Metalli Preziosi



CX F

Applicazioni Leghe e Metalli Preziosi

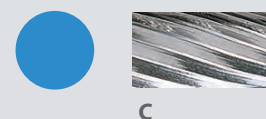

C

Frese 4 lati

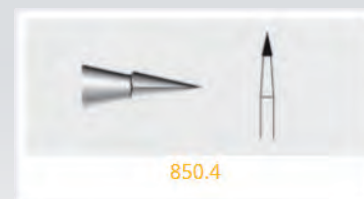

850.4

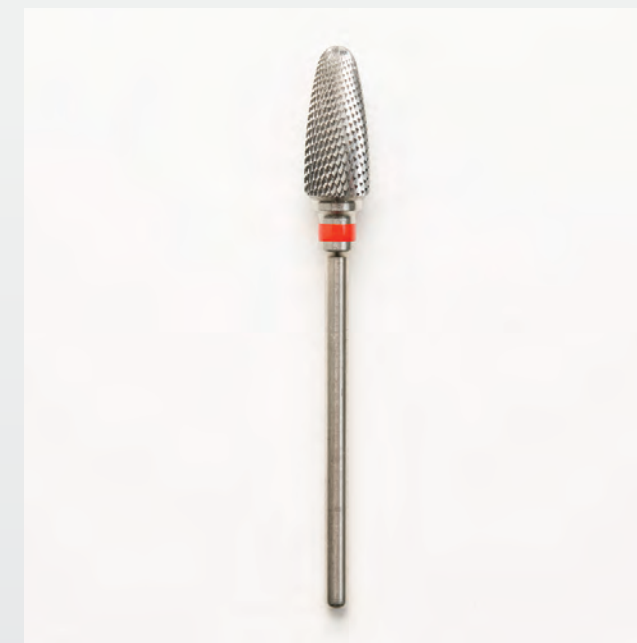

APPLICAZIONE GESSO / Dentatura incrociata supergrossa

CX SG 251

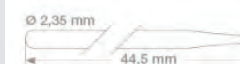

L mm 14

500.104.274.223.

HP CX SG 251. 060

CX SG 351

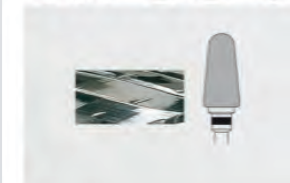

L mm 14

500.104.263.223.

HP CX SG 351. 070



FRESE DENTALI



Laboratorio

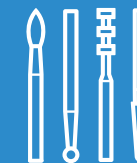

DIAMANTATI CARBURO DI TUNGSTENO LUCIDATRICI VARI

APPLICAZIONE GESSO E RESINA / Dentatura incrociata grossa

CX G 77



L mm 12



500.104.237.220

HP CX G 77. 060

CX G 251

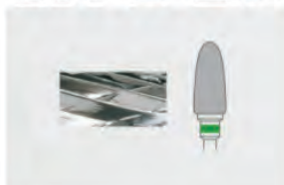

L mm 14



500.104.274.220

HP CX G 251. 060

CX G 351

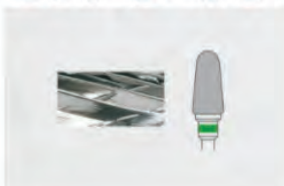

L mm 12



500.104.263.220

HP CX G 351. 060

CX 71



L mm 5



500.104.001.190

HP CX 71. 050

CX 77



L mm 12



500.104.237.190

HP CX 77. 060

CX 78



L mm 12



500.104.257.190

HP CX 78. 060



FRESE DENTALI



Laboratorio

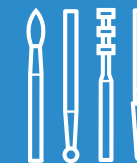

DIAMANTATI CARBURO DI TUNGSTENO LUCIDATRICI VARI

APPLICAZIONI LEGHE E METALLI PREZIOSI / Dentatura incrociata standard

CX 79



500.104.194.190.

HP CX 79. 040 060

CX 261



500.104.194.190.

HP CX 261. 023

CX 251



500.104.274.190.

HP CX 251. 040 060

CX 295



500.104.292.190.

HP CX 295. 023

CX 257-364R



500.104.274.190.

HP CX 257-364R. 023

CX 364R



500.104.137.190.

HP CX 364R. 023



FRESE DENTALI



Laboratorio

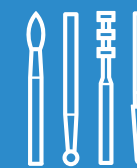

DIAMANTATI CARBURO DI TUNGSTENO LUCIDATRICI VARI

APPLICAZIONI LEGHE E METALLI PREZIOSI / Dentatura incrociata fina

CX F 73

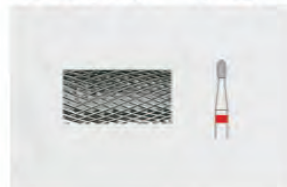

500.104.277.140.

HP CX F 73. 014

CX F 79

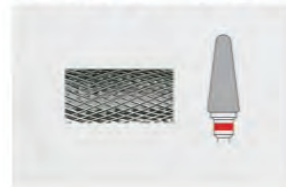

500.104.190.140.

HP CX F 79. 060

CX F 77

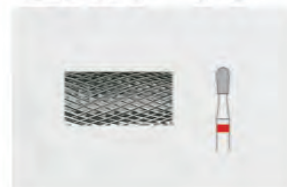

500.104.237.140.

HP CX F 77. 023

CX F 139

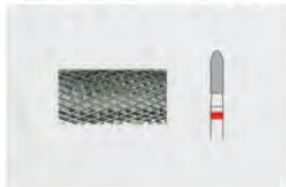

500.104.289.140.

HP CX F 139. 023

CX F 78



500.104.274.140.

HP CX F 78. 040

CX F 251

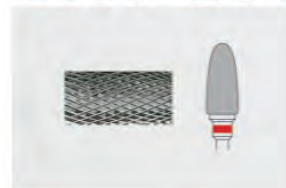

500.104.274.140.

HP CX F 251. 060



FRESE DENTALI



Laboratorio

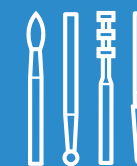

DIAMANTATI CARBURO DI TUNGSTENO LUCIDATRICI VARI

APPLICAZIONI LEGHE E METALLI PREZIOSI / Dentatura incrociata fina

CX F 129

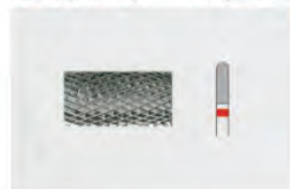

L mm 8

500.104.141.140.

HP CX F 129. 023

CX F 138

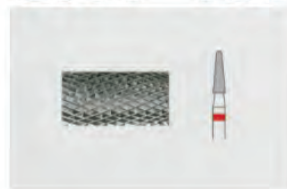

L mm 8

500.104.198.140.

HP CX F 138. 023

C 71



L mm 2.7 3.1

500.104.001.175

HP C 71. 027 031

C 79

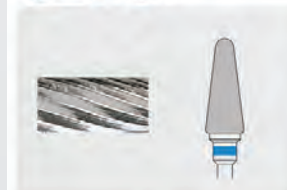

L mm 12

500.104.194.175

HP C 79. 060

FRESE 4 LATI

850.4



L mm 2.5

500.314.467.212.

FG 850.4. 012





FRESE DENTALI



Laboratorio

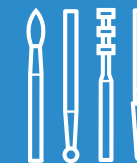

DIAMANTATI CARBURO DI TUNGSTENO **LUCIDATRICI** VARI

ZIRCONIO PRESINTERIZZATO / Media

L0538



L mm 24
Ø mm 10



658.104.275.523.

HP L0538.

ZIRCONIO PRESINTERIZZATO / Fine

L0738



L mm 24
Ø mm 10



658.104.275.513.

HP L0738.

RESINA / Grossa

L1025



L mm 20
Ø mm 10



658.104.300.533.

HP L1025.

L1037



L mm 17
Ø mm 6,5



658.104.275.533.

HP L1037.

L1038

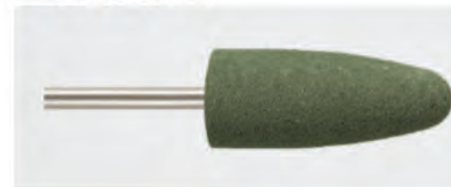

L mm 24
Ø mm 10



658.104.274.533.

HP L1038.





FRESE DENTALI



Laboratorio

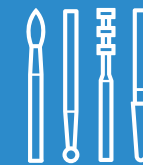

DIAMANTATI CARBURO DI TUNGSTENO **LUCIDATRICI** VARI

RESINA / Media

L2025



L mm 24
Ø mm 10



658.104.300.523.

HP L2025.

L2037



L mm 17
Ø mm 6.5



658.104.275.523.

HP L2037.

L2038



L mm 24
Ø mm 10



658.104.274.523.

HP L2038.

RESINA / Fine

L3025



L mm 24
Ø mm 10

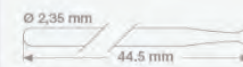

658.104.300.513.

HP L3025.

L3037



L mm 17
Ø mm 6.5



658.104.275.513.

HP L3037.

L3038



L mm 24
Ø mm 10



658.104.274.513.

HP L3038.





FRESE DENTALI



Laboratorio

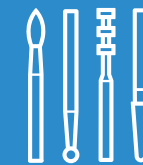

DIAMANTATI CARBURO DI TUNGSTENO **LUCIDATRICI** VARI

PIETRE / Grosso / Diamanti



LX7517



805.104.042.535.

HP LX7517.

L mm 2
Ø mm 12



PIETRE / Media / Diamanti



LX8517



805.104.042.525

HP LX8517.

L mm 2
Ø mm 12



LX7521



805.104.173.535.

HP LX7521.

L mm 10
Ø mm 4



LX8521



805.104.173.525

HP LX8521.

L mm 10
Ø mm 4



LX7531



805.104.107.535.

HP LX7531.

L mm 13
Ø mm 5



LX8531



805.104.107.525

HP LX8531.

L mm 13
Ø mm 5





FRESE DENTALI



DIAMANTATI CARBURO DI TUNGSTENO **LUCIDATRICI** VARI

CERAMICA / Lucidatura preliminare / Diamanti 

LX8013



803.104.543.522

HP LX8013.

L mm 2
Ø mm 26



LX8017



803.104.372.522

HP LX8017.

L mm 2
Ø mm 11



LX8016



803.104.303.522

HP LX8016.

L mm 2
Ø mm 26



LX8024



803.104.243.522

HP LX8024.

L mm 13
Ø mm 4





FRESE DENTALI



Laboratorio

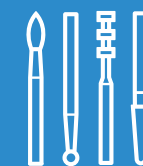

DIAMANTATI CARBURO DI TUNGSTENO **LUCIDATRICI** VARI

CERAMICA / Lucidatura a specchio / Diamanti 

LX9013



L mm 2
Ø mm 26



803.104.543.512

HP LX9013.

LX9016



L mm 2
Ø mm 26



803.104.303.512

HP LX9016.

LX9017

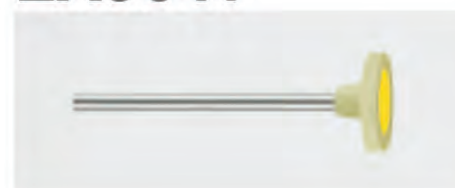

L mm 11
Ø mm 2



803.104.372.512

HP LX9017.

LX9024



L mm 13
Ø mm 4



803.104.243.512

HP LX9024.



FRESE DENTALI

DIAMANTI CARBURO DI TUNGSTENO PULIDORES VARI



Laboratorio

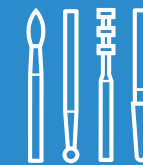

DISCHI RINFORZATI

DR C220



L mm 0.3

Ø mm 22

DR C220.

DR M400

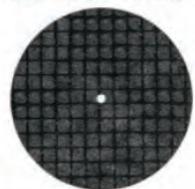

L mm 0.5

Ø mm 40

DR M400.

MANDRIN HP DISQUES



L mm 42



HP MANDRIN HP DISQUES. X

MANDRIN RA DISQUES



RA MANDRIN RA DISQUES.



FRESE DENTALI



Laboratorio

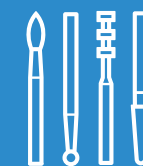

DIAMANTI CARBURO DI TUNGSTENO PULIDORES VARI

ADATTATORI

4024



L mm 13
Ø mm 2.35



RA 4024.

4026



L mm 26
Ø mm 2.35



RA L 4026.

4025



L mm 35
Ø mm 2.35



HP 4025.

4032



L mm 10



RA 4032.



PERNI RADICOLARI

AXIS
dental
SWISS QUALITY



*Soluzione
efficace*



AXIS
dental
SWISS QUALITY





PERNI RADICOLARI

Axis Dental ha disegnato un'avanguardista gamma di perni radicolari di fibra di vetro che offrono un comportamento simile a quello di un dente naturale. Le altezze e diametri sono ideali, i restauri sono più semplici, resistenti e più sicuri.



Efficaci, comodi, duraturi e compatibili

Dentisti e specialisti del settore di tutto il mondo rendono i nostri perni radicolari una soluzione pioniera del mercato grazie ai loro molteplici benefici.

Solo 4 referenze, 2 lunghezze e 2 diametri, soddisfano il 95% dei vostri bisogni.

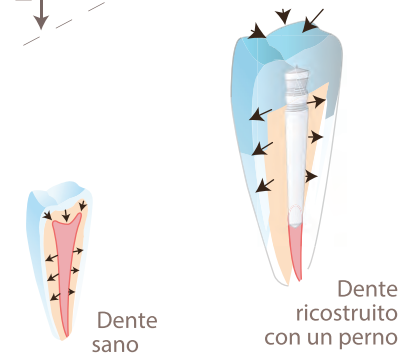
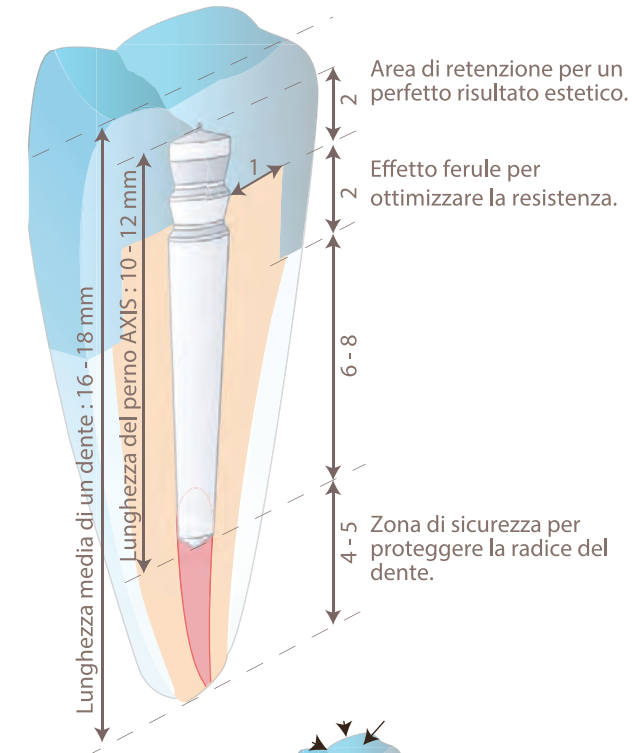

Eccellente ripartizione della forze sulla radice.



PERNI RADICOLARI



FIBRA DI VETRO / SET



FIBERPOST SET

- Set di perni in fibra di vetro
- 2 frese di preparazione
- 2 frese di precisione
- 4 x 5 perni in fibra di vetro
- Istruzioni

FIBRA DI VETRO / BLISTER



FIBERPOST 0.8 - 10MM

5 perni in fibra di vetro
Ø 0.80 - L10 mm



FIBERPOST 0.8 - 12MM

5 perni in fibra di vetro
Ø 0.80 - L12 mm

FIBRA DI VETRO / BLISTER



FIBERPOST 1.0 - 10MM

5 perni in fibra di vetro
Ø 1.00 - L10 mm



FIBERPOST 1.0 - 12MM

5 perni in fibra di vetro
Ø 1.00 - L12 mm



PERNI RADICOLARI



FRESE PER PERNI

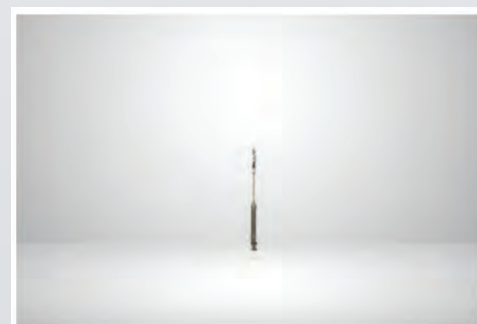

CA XL 183.009
Fresa di preparazione Ø 1.00



CA XL 183.007
Fresa di preparazione Ø 0.80

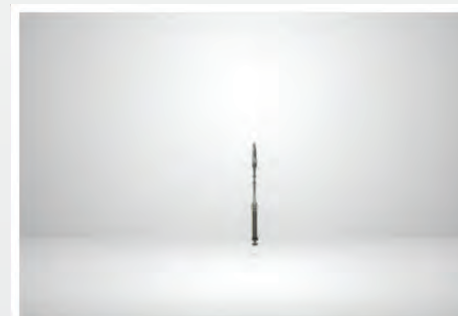

CA XL 196.017
Fresa di precisione Ø 1.00



CA XL 196.015
Fresa di precisione per perni Ø 0.80





SBIANCAMENTO DENTALE

AXIS
dental
SWISS QUALITY



*Soluzione
efficace*

AXIS
dental
SWISS QUALITY





SBIANCAMENTO DENTALE



Con i trattamenti di sbiancamento dentale **PURE** di Axis Dental scoprirai un nuovo sorriso nei tuoi pazienti con cui trasmettere felicità a chi li circonda.



METODO INNOVATIVO ED EFFICACE

PURE è uno sbiancamento dentale riconosciuto per il suo elevato prestigio, garantito dalla sua tecnologia e sviluppo.

I risultati, rapidamente osservabili, garantiscono un sorriso più bianco e brillante per molto tempo. PURE è un trattamento di grande efficacia, senza rischio e molto semplice da utilizzare. Contiene un pH ideale, che offre un'eccellente tolleranza.

Con PURE si nota già nei primi giorni una differenza di colore nei denti.

TRATTAMENTO FACILE E RAPIDO

- Trattamento professionale semplice e sicuro.
- Risultato ottimale e assicurato a lungo termine.



Rapido e sicuro



SBIANCAMENTO DENTALE

IN STUDIO

A CASA

ACCESSORI



In studio

AXIS
dental
SWISS QUALITY



Il modo più veloce per sbiancare i vostri denti: un sorriso luminoso in un ora! Il prodotto va applicato direttamente sui denti, i tessuti molli (gengive) sono protetti. Questo procedimento è senza alcun rischio e non influisce sulla struttura dei denti.



1 giorno



KIT



PURE POWER 38%

Trattamento per 1 singolo paziente
38% di Perossido di Idrogeno
- 1 siringa da 2.5ml
- 1 gingiva Protector da 1.5g
- 1 PURE care da 3ml
- Istruzioni

SIRINGHE INDIVIDUALI



PURE POWER 38% REFILL

1 siringa da 2.5 ml
Istruzioni



PURE GINGIVA PROTECTOR

1 siringa da 1.5
Istruzioni



PURE CARE

Rimineralizzante/ desensibilizzante
1 siringa da 3 ml
- 30% di xilitolo
- 4,2% Nitrate di potassio
- 1450ppm Fluoruro di Sodio
Istruzioni

AXIS
dental
SWISS QUALITY



SBIANCAMENTO DENTALE



A casa

AXIS
dental
SWISS QUALITY



IN STUDIO

A CASA

ACCESSORI



Trattamento flessibile adattato al paziente

Il tuo dentista realizzerà una scansione dei tuoi denti per elaborare le tue ferule personalizzate, garantendoti il miglior trattamento e indicandoti i passi da seguire per ottimizzare il risultato.



Tre opzioni di trattamento in casa

PURE NOTTE

10%
16%
Questi trattamenti di notte vanno bene in tutti i casi. Per denti o colletti sensibili, PURE 10% è la soluzione ideale, il modo più dolce per ottenere dei denti bianchi. Circa 4 ore per 16 notti.



16 notti

PURE LUSTRO

pen
16%
Pennello pratico che fa brillare i denti in modo semplice e sicuro. Da 15 a 20 applicazioni di 20 minuti.



15-20 applicazioni

PEN

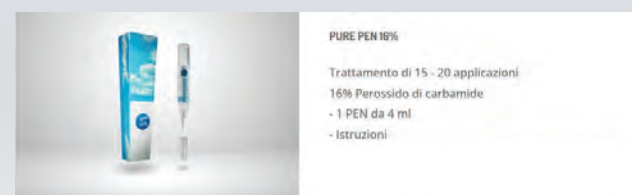

PURE PEN 16%
Trattamento di 15 - 20 applicazioni
16% Perossido di carbamide
- 1 PEN da 4 ml
- Istruzioni

KITS



PURE 10% KIT

Trattamento base di 16 notti
16% di perossido di carbamide
- 4 siringhe da 3 ml
- 1 PURE care da 3 ml
- 2 placche termoformabili
- 1 cofanetto per le mascherine
- 1 tintore
- Istruzioni



PURE 10% KIT

Trattamento base di 16 notti
10% di perossido di carbamide
- 4 siringhe da 3 ml
- 1 PURE care da 3 ml
- 2 placche termoformabili
- 1 cofanetto per le mascherine
- 1 tintore
- Istruzioni



PURE PEN 16% KIT

Trattamento di 15 - 20 applicazioni
16% Perossido di carbamide
- 1 PEN da 4 ml
- 1 Lampada LED
- 1 tintore
- Istruzioni

SIRINGHE INDIVIDUALI



PURE 22% REFILL

Trattamento aggiuntivo di 2 giorni
22% di Perossido di carbamide
- 1 siringa da 3 ml
- Istruzioni



PURE 10% REFILL

Trattamento aggiuntivo di 4 notti
16% di Perossido di carbamide
- 1 siringa da 3 ml
- Istruzioni



PURE 10% REFILL

Trattamento aggiuntivo di 4 notti
10% di Perossido di carbamide
- 1 siringa da 3 ml
- Istruzioni



PURE CARE

Rimineralizzante/ desensibilizzante
1 siringa da 3 ml
- 30% di xilitolo
- 4.2% Nitrato di potassio
- 1450ppm Fluoruro di Sodio
Istruzioni

AXIS
dental
SWISS QUALITY



SBIANCAMENTO DENTALE

IN STUDIO

A CASA

ACCESSORI

AXIS
dental
SWISS QUALITY



Svolgimento del trattamento

Il suo dentista prende l'impronta dei suoi denti per preparare le ferule personalizzate. Il suo dentista fornirà il prodotto più adatto alle sue esigenze e spiegherà il modo di procedere per ottimizzare i risultati.



ACCESSORI



PURE TRAY BOX
Cofanetto per mascherine



PURE THERMO
10 lastre termoformabili
- Quadrato di 12,7 cm di lato
- Spessore 1 mm



PURE LIP RETRACTOR
Autoclavabile



BLOCKER
Resina per serbatoi
- 1 siringa da 1,2 g
- Istruzioni

Continuiamo a rinnovarci continuamente per poter migliorare i nostri prodotti e così agevolare il lavoro dei dentisti nell'applicazione di questi trattamenti così richiesti. **Visita la nostra gamma di accessori nel nostro web.**



AXIS Dental Sarl

Ch. du Cloalet 4
1023 Crissier Switzerland
Tel: +41 21 633 0 633
Email: mail@axis-dental.ch

www.axis-dental.com/es

